

FINEVu

GX300

FineVu GX300 Manual

To prevent an accident or danger, please read "Safety and Instructions" before use and correctly use the product.
(Screens and illustrations in this manual may be different from real ones.)



Thank you for purchasing this FineVu dashcam.

We at Finedigital will do our best to get closer to you.

This manual contains information on how to use and operate your GX300 dashcam.

Before using your dashcam, we recommend that you read through this manual.

It may have a technical or editing error or omission.

To improve the performance of the GX300 dashcam, it may change without prior notice.

Warranty and Support

- The website address of Finedigital is <http://www.finevu.com/en>.
- You can download the latest firmware and manual at the Finedigital website.
- Finedigital does not provide any warranty including suggestive one about sale or compatibility than those permitted by Finedigital.

Copyrights and Trademark

- This manual and all rights for its content are protected under the Copyright Act.
- Any and every part of this manual is prohibited from duplication, copy, revision, or translation without written consent from Finedigital except the cases permitted under the Copyright Act.

Certification

This device passed KN41 (Interference Protection Test for Automobiles and Internal Combustion Engine Motors, Etc.)

This device is a registered one as electromagnetically compatible. Its seller or user should keep it in mind. Such registration is to protect operational features of the vehicle and the driver, passengers and other vehicle users.

- Name(Model) : Dashcam(GX300)
- KC No.: R-R-FDK-FineR032
- Wi-Fi dongle KC : MSIP-CRI-JVS-CF-WU715N
- Company name: Finedigital
- Manufacturer/Country of manufacture : Finedigital/Rep. of Korea
- Customer service: ☎ +82-31-788-8800

Safety and Instructions

Safety symbols	02
Warning	03
Caution	04
Instructions	05

Components and Part Name

Components	06
Optional accessories	07
Names of Parts - Main Unit(Front Camera)	08
Names of Parts - Rear Camera	09

Installation

Inserting the Micro SD card	10
Removing the Micro SD card	10
Combining the mounting bracket	11
Separating the mounting bracket	11
Installing main unit(front camera)	12
Installing the rear camera	14

Main Features

Main Features	16
---------------	----

Using the Product

REC button and its features	17
VOL button and its features	19
Wi-Fi button and its features	20
GPS LED Status	20
Composition of recording folders	21
Name of the recorded video file	21

Using FineVu Wi-Fi App

Installation and connection	22
Description of features	27
Watching Live Streaming	28
Description of the Live Streaming	29
Setting an Installation Angle	30
Watching videos	32
Description of the video player	33
Settings	34
Event Summary (Connected)	43
Description of Event Summary (Connected)	44
Event Summary (Not connected)	45
Description of Event Summary (Not connected)	46
Firmware update on the APP	47

Using FineVu Player

How to install and use FineVu Player	48
System requirements	49
Watching recorded videos and updating firmware on PC	50

Safety symbols



Warning

Describe crucial safety matters on potential hazard which, if not avoided, may result in injury or death.



Caution

Describe matters on the safety of users and proper use of the product regarding a potential hazard which, if not avoided, may result in injury or property damage.



Information

Provide convenience for users.

Warning



Warning

If the user does not comply with the followings, it may result in death or major injury.

Power

- Do not use any damaged or tampered power cable, but only the genuine product of Finedigital. Doing so may lead to safety accidents, such as fire that result in vehicle damage or user injury.
- Do not use with any voltage other than the rated voltage. It may lead to safety accidents, such as fire that result in vehicle damage or user injury.
- Do not connect the power cable to other devices. It may cause fire or product malfunction.

Installation

- Do not install the product at a place where is humid, or where there are combustible liquids or gas. It may cause fire.
- Do not leave the product in a place where the temperature is high, such as in an airtight vehicle or under the direct sunlight, for a long time. It may cause fire or product malfunction.
- Do not install the dashcam where the driver's vision is obstructed while driving. It may lead to a car accident.
- Insert the power, GPS, and video cables properly. Otherwise, it may cause fire or product malfunction.

Use

- Be sure that any metal or flammable materials do not enter the memory card or inlet of codes. It may lead to an electric shock or fire.
- Do not operate the product with wet hands. It may lead to an electric shock.
- Ensure that the product or accessories out of reach of infants or children. They can swallow small parts which may lead them to serious injuries or death.
- Do not cover the product in operation with clothes or blankets. It may heat the product, causing a failure.
- **Do not operate the dashcam while driving. Doing so may result in a car accident.**

Caution



Caution

If the user does not comply with the followings, it may result in injury or property damage.

Installation

- Do not try to install the regular power yourself. It may lead to a failure of the product and vehicle. Make sure that you ask for help from a professional engineer to install it.

Use

- Do not apply force to the lens, lens cover, and outside of the camera. It may cause a failure.
- Do not use a gimlet or sharp object on the product. It may cause a failure.
- If you use the dashcam for a long time, it can get hot. Please be careful.
- Do not disassemble or modify the product yourself.
It may cause damage or data loss, therefore, contact the service center for inspection and repair.
- Make sure that nothing covers the lens while recording.
- If you move the product when the camera is mounted, contact failure can occur.

Management

- Ensure that the product or accessories out of reach of pets.
Foreign materials from them can enter the product, causing a failure.
- If it is likely not to use the product for a long time, do not leave the product plugged in.
It may cause fire or product malfunction.
- Do not move the product in operation while the cigar code or cable is plugged in.
It may lead to fire or an electric shock.



- To improve the performance of the product, its specifications or manual contents may change without prior notice.
- Part or whole of the manual shall not be copied without permission.
- Finedigital is not liable for data and product loss stemming from product failure that may occur in the event of an accident or other cases.

Instructions

The dashcam is a secondary device that takes videos in a certain situation while driving and parking a vehicle and records the video footages in a storage. Please use the recordings as reference data to determine an accident situation. Finedigital shall not take any responsibilities for damage caused by an accident, and provide any support for its result. Please make sure you are fully aware of the followings:

In the case that a recorded file is not found

- **The recording file was deleted due to an over time.**
As the dashcam uses the storage (Micro SD Card) with a limited capacity, videos are deleted from the oldest if the capacity exceeds its limit while recording.
- **Setting the sensitivity of the event detection sensor**
Depending on the sensitivity set level for an event, the event video whose impact strength is less than the set level may not be stored in the event folder or parking folder.
- **Setting the vehicle battery voltage**
When the parking monitoring function is in use, the dashcam monitors the vehicle battery voltage in order to protect the battery, and if the voltage lowers to the voltage set in the dashcam settings, the power of the dashcam is automatically turned off to end its operation.

How to take measures in case of an accident

- When an accident occurs, turn off the power and remove the Micro SD card.
If you continue using the dashcam while the card is not removed, recorded files may be deleted due to an over time.
When you have difficulty in removing the Micro SD card, please turn off the dashcam.
- Back up the accident recordings on your PC.
- Do not connect the removed Micro SD card to your smartphone.
When connecting to your phone, the phone may change the file format, damaging the recorded videos.

In the Package

Components

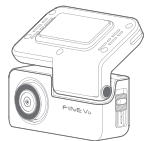

Main unit(Front camera)



Rear camera

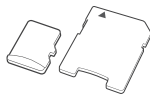

Micro SD card & Adaptor



Hardwire power cable

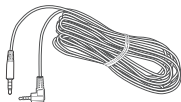

Rear camera cable

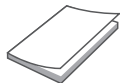

User manual



Quick manual



- To improve the performance of the product, its components may change without prior notice.
- The warranty period of the Micro SD card is 6 months.

Optional accessories



Cigarette lighter power cable

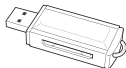

USB SD card reader

Names of Parts

Main Unit (Front Camera)

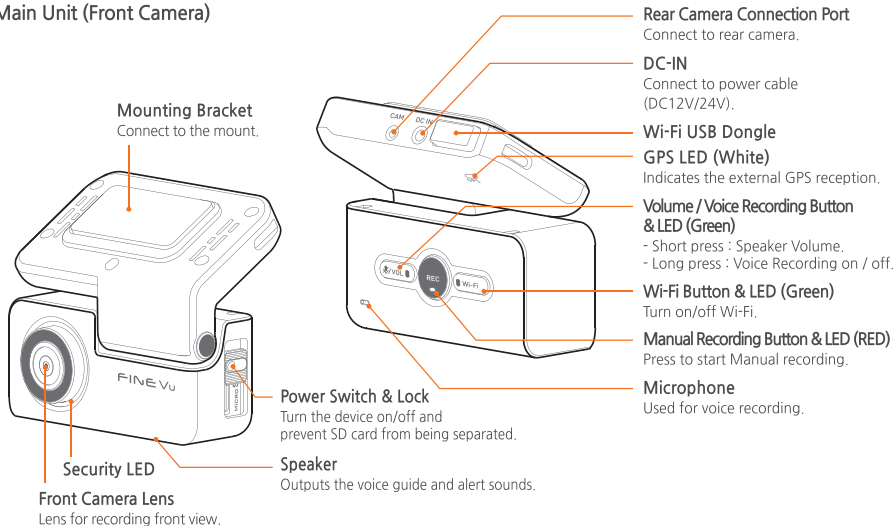

Rear Camera

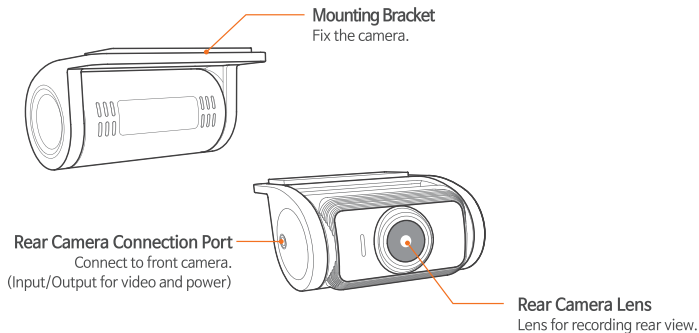

- If a cable other than a dedicated rear camera cable is connected, it may cause damage.
- Security LED of the front camera is originally set as OFF. To use it, user setting is necessary.

Installation

Inserting the Micro SD card

1. Open the power switch & lock.
2. Check the direction for inserting the Micro SD card.
3. Insert the Micro SD card until you hear a click.
4. Close the power switch & lock.

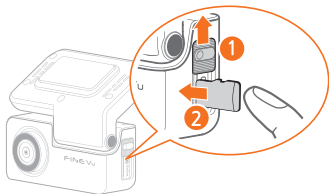

Removing the Micro SD card

1. Open the power switch & lock.
2. Push the inserted Micro SD card.
3. Remove the Micro SD card with your hand after part of it comes out of the product.

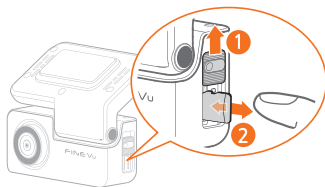

- The power switch & lock is to turn the device on/off and simultaneously prevent the Micro SD card from being separated.
- Push the power switch & lock to turn the product off.



- Use a FineVu genuine memory card. If not, Finedigital does not guarantee its compatibility and normal operation.
- Be careful about the direction for inserting the Micro SD card. If it is wrong, the memory card slot or Micro SD card may be damaged.
- Regularly back up important recorded videos to another storage device.

Combining the mounting bracket

1. Align the mounting bracket to the mount rail on the main unit as arrow mark ①.
2. Push the mounting bracket until you hear a click to fix it to the product as arrow mark ②.

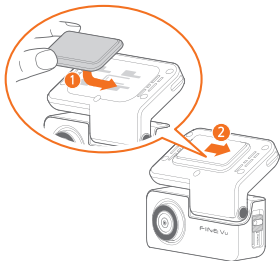

Separating the mounting bracket

1. Push the mounting bracket until you hear a click as arrow mark ①.
2. Separate the mounting bracket as arrow mark ②.

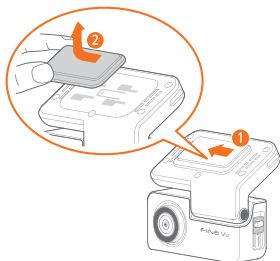

- In combining the mounting bracket, carefully align its left and right sides. If you forcefully combine it in the wrong direction, the product may be damaged.

Installation

Installing the main unit (front camera)

1. Select an installation location.

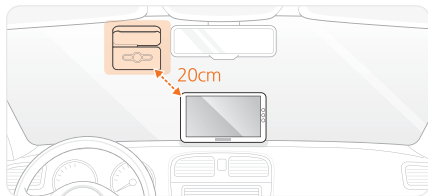

- Select an installation location more than 20 cm away from other electronic devices like a navigation device.
- Install the camera without obstructing the driver's vision.

2. Remove the protective film of the front camera.

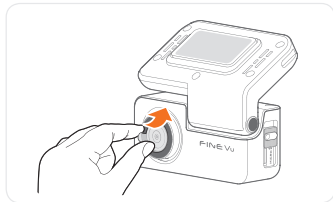

3. Remove the protective film from the adhesive mount.

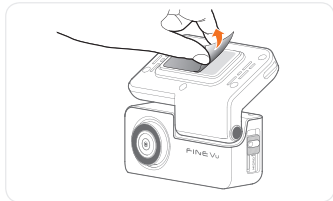

4. Press the mount to the installation location.

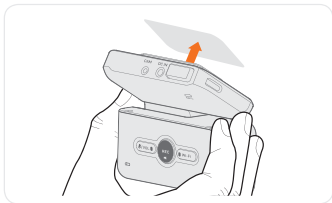

5. Connect the mount to the hardwire power cable which is linked with the fuse box.

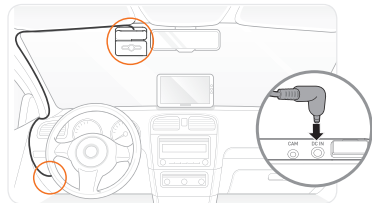

6. After installation, connect FineVu Wi-Fi APP and adjust the video angle.
(For details, refer to the description on the APP.)

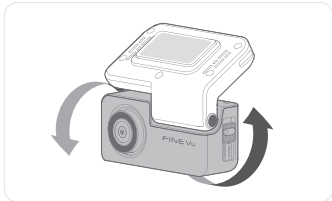

14 Installation

Installing the rear camera

1. Select an installation location.

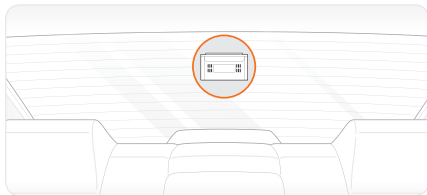

- Install the camera without obstructing the driver's vision.

2. Remove the protective film of the rear camera.

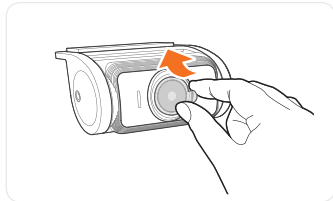

3. Remove the protective film from the adhesive mount.

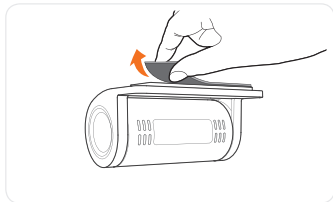

4. Attach the rear camera to the installation location.

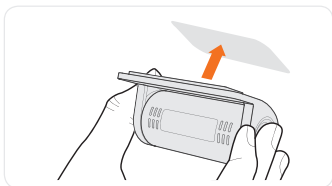

6. Connect the rear camera cable to the front camera.

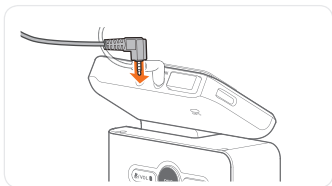

5. Connect the rear camera to the rear camera cable.

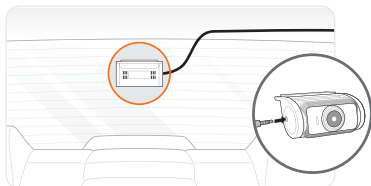

7. After installation, connect the FineVu Wi-Fi APP and adjust the video angle.

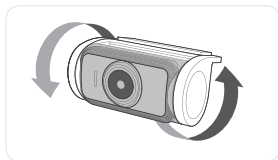

- Use genuine Finedigital accessories.
- Cables of other manufacturers may damage the product or result in fire or electric shock due to different voltage.
- Use regular power during parking recording. As the regular power should be connected separately except some vehicle types, ask for help from an installation specialist. (using regular power is recommended to prevent battery discharge of the vehicle.)
- In connecting a hardwire power cable, be careful about connecting location of each wire.
- Do not cut or modify the included genuine cable yourself.

Main Features

	<ul style="list-style-type: none"> With a SONY Exmor R STARVIS™ image sensor, it provides more bright and clean image resolution than ordinary CMOS sensors even at night. In addition, with the Auto Night Vision function, it provides clearer image quality in dark alleys or underground parking lots.
Record High Resolution Video	<ul style="list-style-type: none"> Record the front view in QHD (2560x1440p@30fps) and rear view in FHD (1920x1080p@30fps) through a high performance
FineVu Wi-Fi APP	<ul style="list-style-type: none"> Easily check dashcam setting and video through the FineVu Wi-Fi APP.
HDR	<ul style="list-style-type: none"> Clearly record video with FineVu's tuning technology under various illuminance changes - backlight, night driving, entrance/exit of tunnels and parking lots, etc.
Auto Night Vision	<ul style="list-style-type: none"> Minimize deterioration of image quality and record a bright image at a place of low illuminance or during night driving and parking.
Speed Camera Alert	<ul style="list-style-type: none"> Provide in voice guidance 7 types of camera information such as a speed camera, Red light and speed limit camera and average speed. * This feature may not be supported depending on the country.
Smart Time Lapse 1.0	<ul style="list-style-type: none"> This is an intermittent recording mode in which the camera takes photos of motion at a consistent interval and reproduces them at normal speed. It enables you to check recorded videos quickly by setting time lapses in driving and parking mode. Record video in standard 30fps when an event occurs in driving and parking mode.
ADAS	<ul style="list-style-type: none"> The ADAS (Advanced Driver Assistance System) supports functions like the front vehicle motion alert (FVMA) (It operates when GPS signals are received).

Using the Product

REC button and its features





















Image	LED Status	Mode	Description
	 OFF	-	<ul style="list-style-type: none"> Power OFF
	 ON →  OFF	Memory card format	<ul style="list-style-type: none"> When you press the 'REC' button for more than 2 seconds. Then memory card will be formatted and system restarts simultaneously with an information message.
	 ON	Driving recording	<ul style="list-style-type: none"> After the product is completely booted up, the driving recording mode starts. During driving, videos are recorded in 1 minute segments and stored in the "normal" folder in the memory card.
		Driving time lapse recording	<ul style="list-style-type: none"> Tap [Install and Execute APP ▶ Settings ▶ Record] for setting. The recorded videos are stored in the "normal" folder in the memory card.
	 Blink	Impact detection recording	<ul style="list-style-type: none"> When an impact is detected in driving recording mode, the event detection recording mode starts. A video is recorded for 20 seconds, from the moment 10 seconds before detection to 10 seconds after detection, and stored in the "event" folder in the memory card.
		Impact detection recording in driving time lapse recording mode	<ul style="list-style-type: none"> When an impact is detected in driving time lapse recording mode, the event detection recording mode starts. A video is recorded for 20 seconds, from the moment 10 seconds before detection to 10 seconds after detection, and stored in the "event" folder in the memory card. The recorded video is automatically recorded and stored at a rate of 30fps, not time lapse.
Manual recording		<ul style="list-style-type: none"> When you press the 'REC' button shortly on the device, it turns red and the manual recording mode starts. A video is recorded for 20 seconds, from the moment 10 seconds before pressing the button and to 10 seconds after pressing the button, and stored in the "camcorder" folder in the memory card. 	

Image	LED Status	Mode	Description
	 Blink	Switch to parking recording	<ul style="list-style-type: none"> If you turn off the vehicle with regular power connected, the parking recording mode starts. If you turn on the vehicle, the driving recording mode starts again.
		Parking time lapse recording	<ul style="list-style-type: none"> Tap [Install and Execute APP ► Settings ► Record] for setting. The recorded videos are stored in the "motion" folder in the memory card. * Continue to record video in time lapse regardless of motion detection.
		Impact detection recording	<ul style="list-style-type: none"> When an impact is detected during parking, the event detection recording mode starts. A video is recorded for 20 seconds, from the moment 10 seconds before detection to 10 seconds after detection, and stored in the "parking" folder in the memory card.
		Impact detection recording in parking time lapse recording mode	<ul style="list-style-type: none"> When an impact is detected in parking time lapse recording mode, the event detection recording mode starts. A video is recorded for 20 seconds, from the moment 10 seconds before detection to 10 seconds after detection, and stored in the "parking" folder in the memory card. The recorded video is automatically recorded and stored at a rate of 30fps, not time lapse.
		Motion detection recording	<ul style="list-style-type: none"> When motion is detected in parking recording mode, the event detection recording mode starts. A video is recorded for 20 seconds, from the moment 10 seconds before detection to 10 seconds after detection, and stored in the "motion" folder in the memory card.

VOL button and its features





Image	LED Status	Mode	Description
	 ON	Voice recording ON	<ul style="list-style-type: none"> Record voice on the recorded video. With voice recording OFF, press the  button for more than 2 seconds. Then, with an information message, voice recording turns on.
	 OFF	Voice recording OFF	<ul style="list-style-type: none"> Record the recorded video without voice. With voice recording ON, press the  button for more than 2 seconds. Then, with an information message, voice recording turns off.
	No change	Volume adjustment	<ul style="list-style-type: none"> After the product is turned on, press the  button shortly and you can adjust the volume of an information message from 5 levels (0 to 4).

Wi-Fi button and its features





Image	LED Status	Mode	Description
	 ON	Wi-Fi ON	<ul style="list-style-type: none"> With Wi-Fi OFF, press the  button shortly and Wi-Fi is activated simultaneously with an information message.
	 OFF	Wi-Fi OFF	<ul style="list-style-type: none"> With Wi-Fi ON, press the  button shortly and Wi-Fi is inactivated simultaneously with an information message.
	Blink	Wi-Fi connection standby mode	<ul style="list-style-type: none"> This represents that Wi-Fi is in standby mode because it is on but not connected to the mobile phone. * With no connection Wi-Fi standby mode will be turned off after 120 seconds.
	No change	Reset Wi-Fi	<ul style="list-style-type: none"> When you have forgotten the Wi-Fi password, press the  button for more than 2 seconds. Then, the password is reset simultaneously with an information message. * The initial password is '12345678'

GPS LED Status

* GPS LED color is displayed in white.

Image	LED Status	Mode	Description
	 GPS	GPS reception completed	<ul style="list-style-type: none"> If GPS reception is completed, the LED remains ON.
	 OFF	GPS reception error	<ul style="list-style-type: none"> If GPS reception errors or other defects occur, the LED turns to the OFF status.
	 Blink	Receiving GPS	<ul style="list-style-type: none"> During GPS reception, the LED blinks.

Composition of recording folders

Recording Type	Driving recording (Driving time lapse)	Driving event	Parking event	Parking motion (Parking time lapse)	Manual Recording
Folder Name	 Normal	 Event	 Parking	 Motion	 Camcorder

Name of the recorded video file

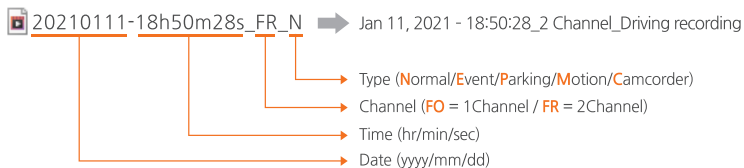



- During parking, only impact and motion detection videos are recorded. (set time lapse separately)
- The parking motion detection and parking time lapse recording mode cannot be used at the same time.
- For time lapse recording, voice is not recorded.

Using FineVu Wi-Fi App

Installation and connection

• Initial connection

1. Download 'FineVu Wi-Fi' APP at Google Play Store() or APP Store() according to smartphone types.
2. Execute 'FineVu Wi-Fi' APP on the smartphone.
3. The information popup for dashcam connection is provided one time for initial connection.
4. After the screen for dashcam connection appears, press the  button on the main unit and activate Wi-Fi.
5. If Wi-Fi is powered on, connect Wi-Fi starting with 'FineVu_GX300' in the smartphone Wi-Fi list.
(The initial password is '12345678')
6. If the smartphone and the dashcam are connected using Wi-Fi, return to the APP.



• Re-connection

1. Execute 'FineVu Wi-Fi' APP on the smartphone.
2. Press the  button on the main unit and activate Wi-Fi.
3. Connect Wi-Fi starting with 'FineVu_GX300' in the smartphone Wi-Fi list.
4. If the smartphone and product are connected using Wi-Fi, return to the APP.



- With the smartphone and the dashcam are connected using Wi-Fi, the smartphone is in offline status and data are temporarily cut off.
- If the smartphone and the product are disconnected, the status returns to the original one.

- Initial connection

1. Search and download and execute 'FineVu Wi-Fi' APP at Google Play Store () or APP Store () according to smartphone types.

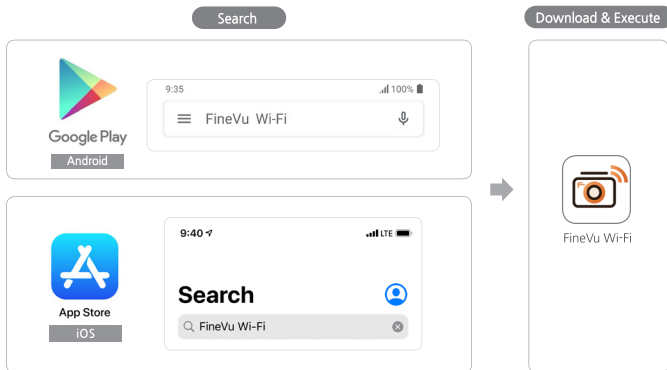

24 Using FineVu Wi-Fi App

- The information popup for dashcam connection is provided one time for initial connection.
- After the screen for dashcam connection appears, press  on the main unit and activate Wi-Fi.
- If Wi-Fi is powered on, connect Wi-Fi starting with 'FineVu_GX300' in the smartphone Wi-Fi list.
(The initial password is '12345678')
- As Android and iOS have differently connecting methods, refer to the following illustrations.

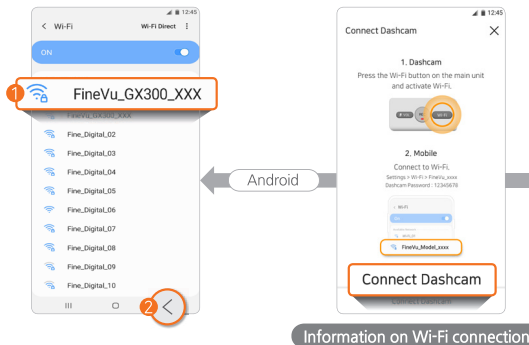

- Move to the APP Settings screen and set GPS ON to use this feature perfectly.

6. During Wi-Fi connection, set GPS ON in APP Settings.

7. After Wi-Fi connection, return to the APP by touching 'Back' (Android) or 'FineVu Wi-Fi'(iOS) at the left top of the screen.

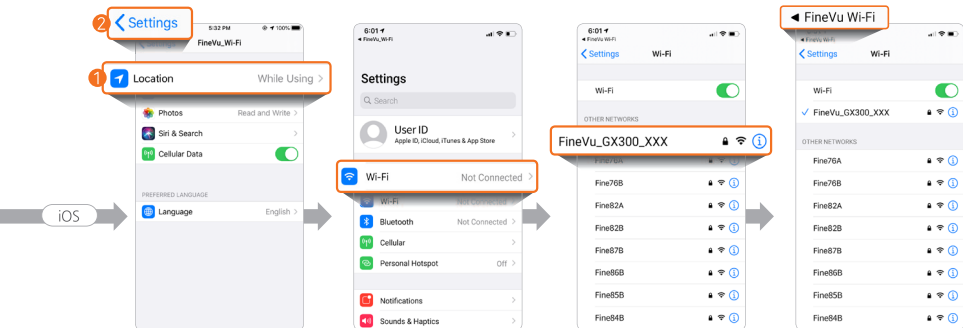

- Move to the APP Settings screen and set GPS ON. Then, move to Wi-Fi Settings.

8. If the APP is connected, the main screen shows up.

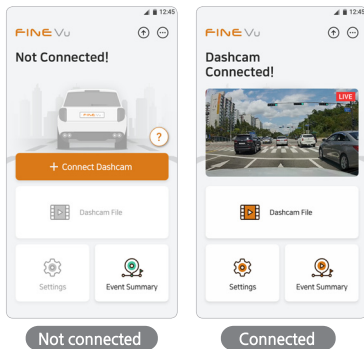

- With the smartphone and the dashcam are connected using Wi-Fi, the smartphone is in offline status and data are temporarily cut off.
- If the smartphone and the dashcam are disconnected, the status returns to the original one.

• Re-connection

1. Execute 'FineVu Wi-Fi' APP on the smartphone.
2. Press the  button on the main unit and activate Wi-Fi.
3. Connect Wi-Fi starting with 'FineVu_GX300' in the smartphone Wi-Fi list.
4. If the smartphone and product are connected using Wi-Fi, return to the APP.

Description of features

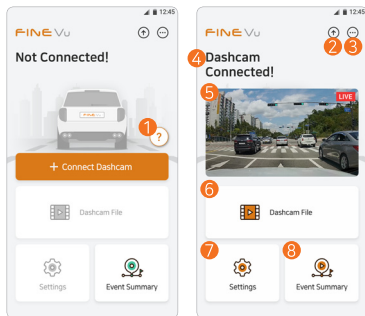

No.	Description
①	Check 'Dashcam Connected' with an automatic popup window one time for initial connection (Check the initial Wi-Fi password.) (The button will disappear when the dashcam is connected)
②	Check the product name, and the current and latest versions of its APP, Speed cam, and Firmware.
③	Check the open source license.
④	Show whether the dashcam is connected.
⑤	Check Live View of the connected dashcam. (If not connected, the '+Connect Dashcam' button appears.)
⑥	Check recorded videos of the dashcam.
⑦	Change settings of the dashcam.
⑧	Check event summaries of the dashcam.



- If the dashcam is not connected, inactivated features like Live View or Dashcam File are not offered.

Watching Live Streaming

1. Execute 'FineVu Wi-Fi' APP and connect dashcam Wi-Fi. (refer to 'Using FineVu Wi-Fi APP > Installation and connection')
2. Tap the image that provides 'Live View' on the main screen.
3. Support front & rear Live View, angle setting, screenshot, etc.

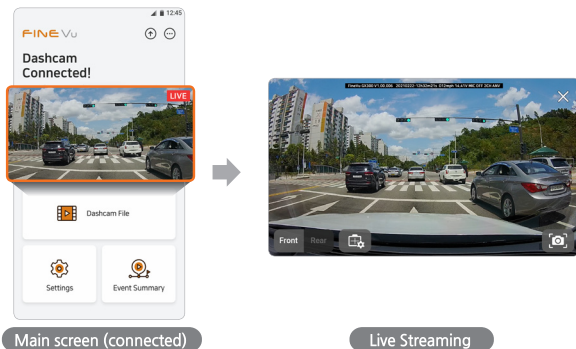

 • If the dashcam is not connected, this feature is not offered.

Description of the Live Streaming

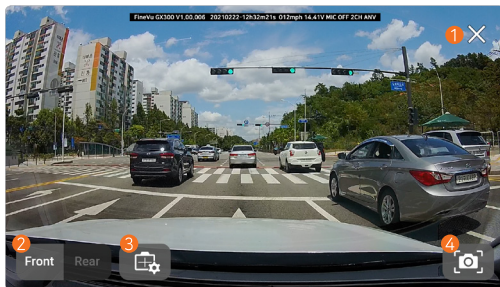

No.	Name	Description
①	Close	Close Live View and return to the main screen.
②	Switch the front/ rear direction	Select front & rear Live View.
③	Set a installation angle	Set a installation angle. (refer to Using 'FineVu Wi-Fi APP > Description on the installation angle')
④	Screenshot	Screenshot the moment and save the image to a photo album by tapping the icon.

Setting an Installation Angle

1. Execute FineVu Wi-Fi APP and connect dashcam Wi-Fi. (refer to 'Using FineVu Wi-Fi APP > Installation and connect')
2. Tap the image that provides 'Live View' on the main screen.
3. Press the  button on the Live View screen.

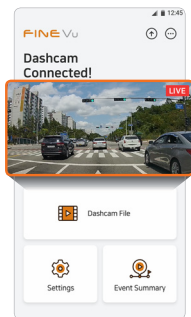

Main screen (connected)

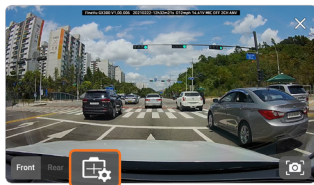

Live Streaming

 • If the dashcam is not connected, this feature is not offered.

4. Set a installation angle in order of the following steps.

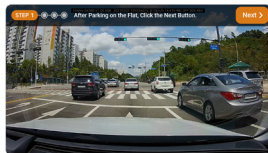

Step 1. Park the car on the flat place and press the Next button.



Step 2. Select the car type.

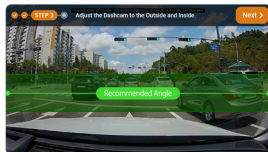

Step 3. Place the 'Recommended Angle' line inside the recommended angle area by adjusting the front camera angle.
If the angle is out of the area, the line displays in red.

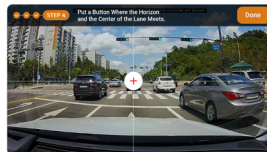
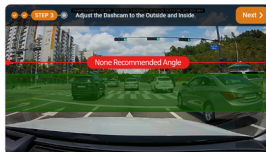

Step 4. Put + where the horizon and the center of the lane meets.



- Set the angle at a safe place where does not disturb nearby cars.
- Please set it to improve ADAS accuracy.

Watching videos

1. Execute FineVu Wi-Fi APP and connect dashcam Wi-Fi. (refer to 'Using FineVu Wi-Fi APP > Installation and connect')
2. Tap the 'Dashcam File' button on the main screen.
3. The recorded video list shows up and you can view all or check lists by desired video type and date.
4. You can play back videos through the APP Player.

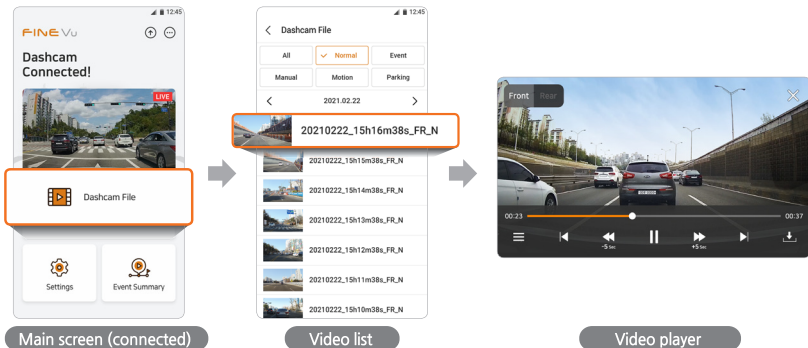

- Video play supports only the landscape mode of the smartphone.
- If there is no video, the list is not offered.

Description of the video player

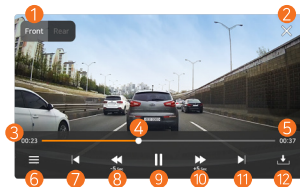

No.	Name	Description
①	Switch the front/rear direction	Select front & rear view videos.
②	Close	Close the playing video and return to the previous list.
③	Play time	Show the playing time from 00:00.
④	Play bar	You can move to the beginning and the end of the video with this bar. If you drag it, you can move to the desired time.
⑤	Remaining time	Show the remaining time for which the play time of the video is subtracted from the total time.
⑥	Playlist	Show the video list that can be played.
⑦	Previous video	Move to the previous video in the list.
⑧	Rewind	Go back to 5 sec before the current video.
⑨	Pause	Stop the current video temporarily.
⑩	Fast forward	Go to 5 sec after the current video.
⑪	Next video	Move to the next video in the list.
⑫	Download	Download the current video. The downloaded video is stored in the smartphone.

Settings

1. Execute 'FineVu Wi-Fi' APP and connect dashcam Wi-Fi. (refer to 'Using FineVu Wi-Fi APP > Installation and connect')
2. Tap the 'Settings' button on the main screen.
3. You can change settings by selecting a menu that you want.

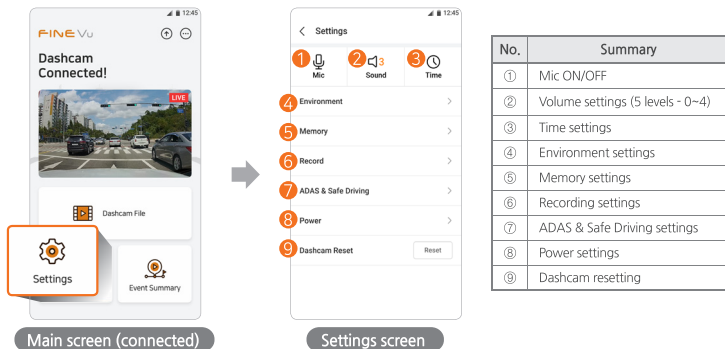

- If the dashcam is not connected, this feature is not offered.
- When you change dashcam settings, the memory card may be reset. In that case, a popup shows up on the APP. Please read it carefully.

Tap [Settings ► ] to turn ON/OFF voice recording while recording video as ❶ below.

Tap [Settings ► ] to adjust dashcam information sounds & messages in 5 levels ranging from 0 to 4.

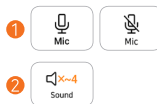
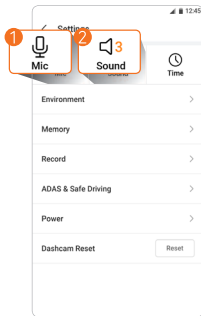

Tap [Settings ▶ ] to set the UTC Time Zone and turn Summer Time ON/OFF.
(set UTC from -11 to +14.)

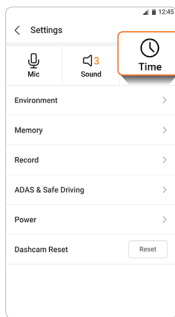

Settings screen

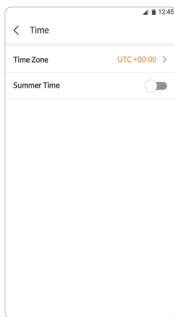

Settings screen > Time

· UTC Guide

Area	UTC Time Zone
LA	-8
Vancouver	-8
Denver	-7
Chicago	-6
Mexico City	-6
New York	-5
Washington D.C.	-5
Sao Paulo	-3
London	0
Berlin	+1
Rome	+1
Moscow	+3
Beijing	+8
Taipei	+8
Seoul	+9
Tokyo	+9
Sidney	+10



· This UTC guide is just for reference. Set the accurate UTC time zone in the area of your residence or usage.

Tap [Settings ► Environment] to change the Wi-Fi Password or Speed Unit.

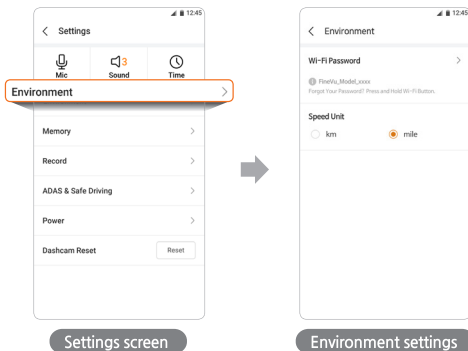

- If you forget your password, you can press  button for more than 2 sec to reset. (refer to 'Using the Product > Description on buttons')

Tap [Settings ► Memory] to select one from 4 memory partitions.
(Driving Priority, Event Priority, Parking Priority and Driving Only)

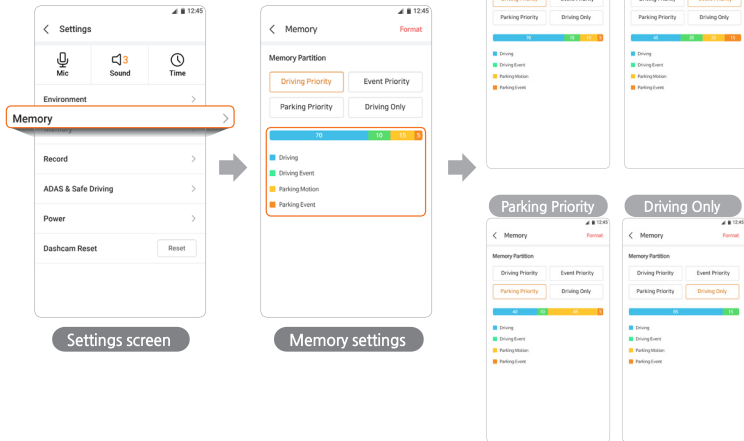

Tap [Settings ► Record] to set in detail Driving and Parking Recording, Event sensitivity, Security LED ON/OFF, HDR ON/OFF etc.

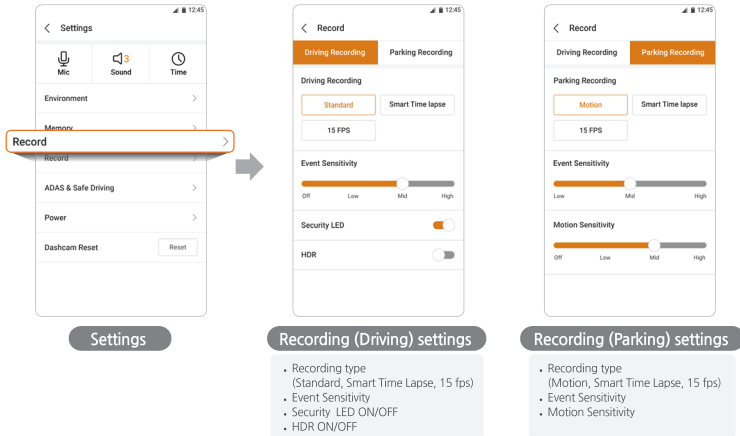

- Recording type (Standard, Smart Time Lapse, 15 fps)
- Event Sensitivity
- Security LED ON/OFF
- HDR ON/OFF

- Recording type (Motion, Smart Time Lapse, 15 fps)
- Event Sensitivity
- Motion Sensitivity

Tap [Settings ► ADAS & Safe Driving] to set in detail the messages for the Front vehicle motion alert (FVMA), Speed Camera Notification, On Time Notification and Driving Rest Notification.

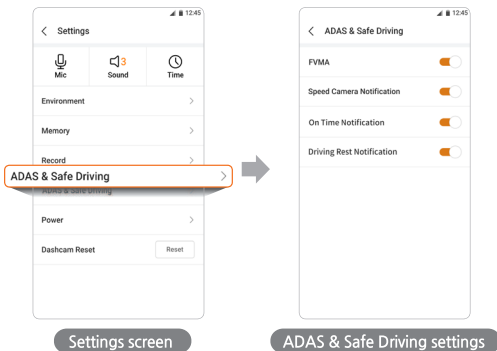

Tap [Settings ► Power] to set Low Voltage and Cut-off Time.

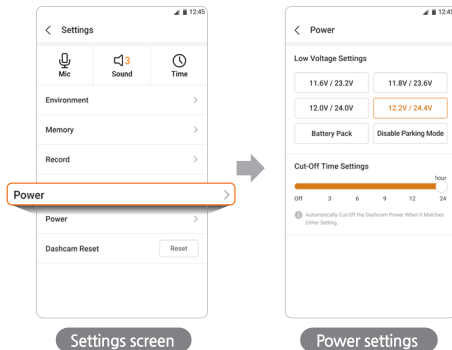

Tap [Settings ► Dashcam Reset] button to reset the dashcam settings and the memory card.

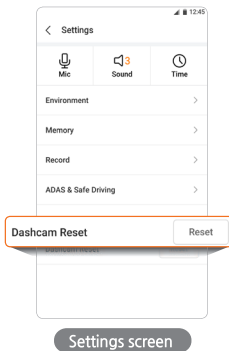

- As the memory card is formatted during resetting of the dashcam, store important videos separately before the work.

Event Summary (Connected)

Check event details through Event Summary and provide the event video or map data.

1. Execute 'FineVu Wi-Fi' APP and connect dashcam Wi-Fi. (refer to 'Using FineVu Wi-Fi APP > Installation and connection')
2. Tap the 'Event Summary' button on the main screen.
3. Press the  button to check the relevant video.

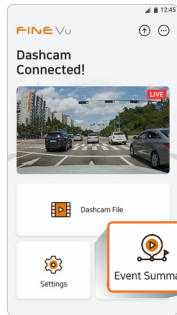

Main screen (connected)

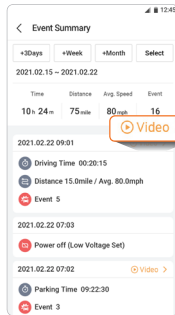

Event Summary screen (connected)

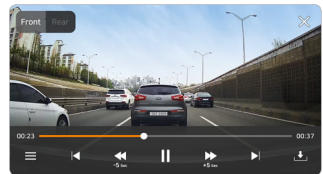

Video player



- If there are no data, the list is not provided.
- If the dashcam is not connected, a map screen is offered instead of a video screen.

Description of Event Summary (Connected)

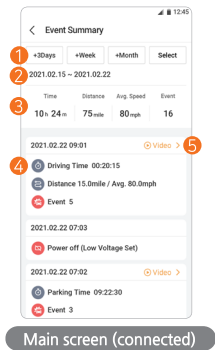

No.	Description
①	Select an option: 3 days, week, month, or user setting period.
②	Select a period.
③	Driving time, distance, average speed and the number of events during the selected period.
④	Summary on power ON/OFF and the number of events during the selected period.
⑤	Play the relevant video (if there are several videos, the list is offered).

Event Summary (Not Connected)

Check event details through Event Summary and provide the event video or map data.

1. Execute 'FineVu Wi-Fi' APP and connect dashcam Wi-Fi. (refer to 'Using FineVu Wi-Fi APP > Installation and connection')
2. Tap the 'Event Summary' button on the main screen.
3. Press the **Map >** button to check information on the relevant map and departure/arrival place.

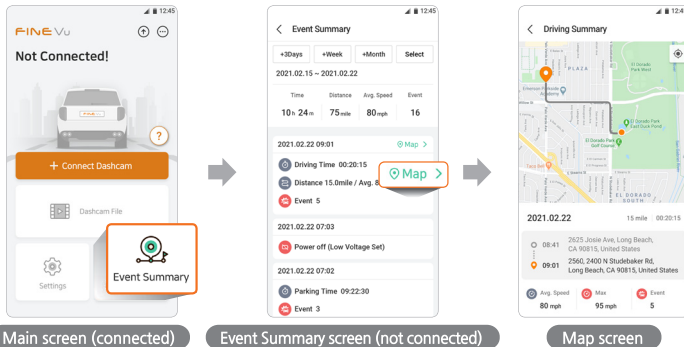

- If there are no data, the list is not provided.
- If the dashcam is connected, a video screen is offered instead of a map screen.

Description of Event Summary (Not Connected)

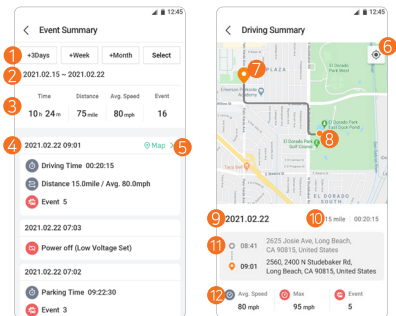

No.	Description
①	Select an option: 3 days, week, month, or user setting period.
②	Select a period.
③	Driving time, distance, average speed and the number of events during the selected period
④	Summary on power ON/OFF and the number of events during the selected period
⑤	Map and details
⑥	Move to the current location
⑦	Departure place
⑧	Arrival place
⑨	Date
⑩	Driving time and distance
⑪	Departure/arrival time and address
⑫	Average and maximum speed, and the number of events

Firmware update on the APP

1. Connect the dashcam and click  at the right top of the main screen.
2. Check the name of the connected dashcam and current and new versions of its APP, Speed cam, and Firmware.
3. If the versions are not the new ones, tap **Update** to update them.

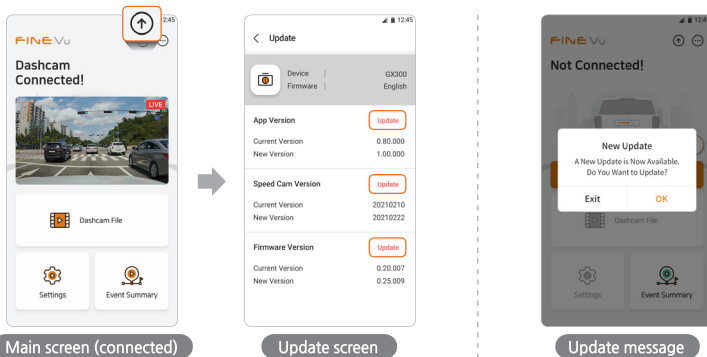

- This APP informs you of an update through a popup when the dashcam is connected. Click the OK button for an update.
- The update popup may not appear depending on the conditions like a connection status, etc.

Using FineVu Player

How to install and use FineVu Player

FineVu Player is software that you can play the videos recorded by the FineVu dashcam. You can download it at the FineVu website(<http://www.FineVu.com/en>).

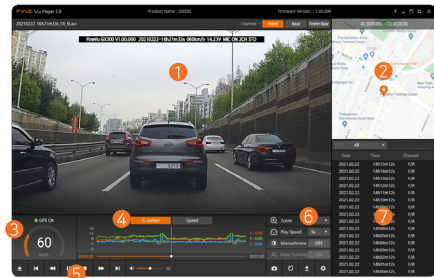

No.	Description
①	Main screen that plays back a recorded video.
②	If GPS data are included in the recorded video, the location is displayed in the map.
③	If GPS data are included in the recorded video, the speed is displayed.
④	Display G-Sensor values or speeds in a graph.
⑤	Menu for playing and backing up video and setting the player
⑥	Menu for analyzing recorded videos
⑦	Display the video list.



- The FineVu player supports both Mac and Windows.
- Please use the 'FineVu player', or the video playback may be limited.

System requirements

Windows	Minimum	Recommended
OS	Windows 7 or higher	Windows 10, 64bit OS
HDD	70MB or greater	150MB
CPU	Intel Dual Core 3.4GHz or higher (32bit) Intel Dual Core 2.8GHz or higher (64bit)	Intel Dual Core 3.4GHz
VGA	256MB or greater	1GB
RAM	2GB or greater	4GB
DirectX	DirectX 11 or higher	DirectX 12
Monitor	1280 x 1024 or greater	1920 x 1080

Mac	Minimum	Recommended
OS	10.14	10.15
HDD	1GB of available storage	10GB of available storage
CPU	64bit Inter Processor	64bit Inter Dual Core Processor
VGA	Inter Iris Graphics 4000 series or later	External VGA card
RAM	2GB	4GB
Monitor	12 Inch 1280x800	1920x1080

Watching recorded videos and updating firmware on PC

• Watching recorded videos on PC

1. Remove the Micro SD card from the device, and insert it into the adapter.
Connect the card to the PC using the Micro SD card reader.
2. When the Micro SD card reader is connected to the PC, a USB drive or new disk drive will be created.
3. Click the relevant folder and select video files you want to play back or view.
4. FineVu Player or other players can be used to watch recorded video.
(You should use FineVu Player to check the GPS and G-Sensor information of the recorded video.)

• Updating firmware on PC

1. Download the latest firmware at FineVu website. (<http://www.FineVu.com/en>)
2. Remove the Micro SD card. Insert it into Micro SD card reader and connect the reader to the PC.
3. When the reader is connected to the PC, a USB drive or new disk drive will be created.
(It's recommended to format the Micro SD card used for another device before you upgrade the firmware.)
4. Unzip the downloaded file, and copy it to the top-level root of the memory card.
5. Insert the copied Micro SD card into on the device. Turn on the vehicle (ACC On) or start the engine to turn on the device.
6. The firmware update starts automatically.
7. The system will automatically restart once the firmware update is completed.



• To insert or remove the Micro SD card, refer to 'Installation' in the previous pages.

SPECIFICATION

ITEM	SPECIFICATION		REMARKS
Model name	FineVu GX300		
Size/Weight	Front : 78.0 x 64.5 x 50mm / 120g Rear : 53.4 x 30.3 x 41.5mm / 27g		Weight including the mount
Memory capacity	Micro SD card	32GB / 64GB / 128GB	Class 10 or above, UHS-1 recommended, SDXC compatible
Recording mode	Driving recording		1 min. interval recording
	Driving event(impact) recording		20 sec. recording(10 seconds before and after detection)
	Manual recording		20 sec. recording(10 seconds before and after detection)
	Parking (impact & motion detection) recording		20 sec. recording(10 seconds before and after detection)
	Driving time lapse recording		30fps recording after impact detected
	Parking time lapse recording		30fps recording after impact detected
Lens	Front : Quad HD wide-angle lens Rear : Full HD wide-angle lens		
Image sensor	Front : 5.14M pixels, 1/2.8" SONY Exmor R STARVIS Image Sensor Rear : 2M pixels, 1/3" CMOS Image Sensor		
Viewing angle	Front : more than 122° of the opposite angle / 104° of the horizontal angle / 56.4° of the vertical angle Rear : more than 134° of the opposite angle / 105° of the horizontal angle / 80° of the vertical angle		
Video	Front : 2560X1440p@30fps Rear : 1920X1080p@30fps		
Encoding	Voice: PCM		.MP4(2Video-1Audio)
GPS	Built-in		
Voice	Built-in		
Speaker	Built-in		
Acceleration sensor	3-axis acceleration sensor		+2g / -2g

ITEM	SPECIFICATION	REMARKS
Input power	DC 12V - 24V	
Battery	Super capacitor	Supply power to safely store video in case of external shutoff
Power consumption	4.1W	Based on 2ch, GPS ON
Operation/ Storage temperature	Operation temperature -20℃~70℃ / storage temperature -30℃~80℃	
Interface	Power port (3.5 ϕ), rear camera connection port (2.5 ϕ), USB A type Wi-Fi port	
Function	Smart Time Lapse, FineVu Wi-Fi, Speed Camera Alert, HDR, ADAS, Installation Angle Guide, Format Free, Auto Night Vision, Driving Rest Guide, Time Alarm, Battery Discharge Prevention, Support 1ch recording, High Temperature Protection	Vehicle speed, ADAS and Speed Camera Alert operate under GPS reception.
Certification No.	KC (R-R-FDK-FineR032) Wi-Fi dongle KC (MSIP-CRI-JVS-CF-WU715N) Model name: FineVu GX300 Date of manufacture: Marked separately Name(Model) : Dashcam(GX300) Manufacturer: Finedigital Inc. Company name: Finedigital Inc. Manufacturing country: Rep. of Korea	Passed KN41 (EMC test for vehicles, and internal combustion engines)

WARRANTY

Limited Warranty

This device is guaranteed against manufacturing defects for one(1) year(six(6) months for battery and accessories) from the original date of purchase.

Finedigital's sole obligation in the event of such defects during this period is to repair or replace the defective part or device with a comparable part or device at Finedigital's sole discretion.

Except for such replacement, the sale, or other handling of this device is without warranty, condition or other liability even though the defect or loss is caused by negligence or other fault.

Damage resulting from use, accident, or normal wear and tear is not covered by this or any warranty.

Finedigital assumes no liability for any accident, injury, death, loss or other claim related to or resulting from the use of this device. In no event shall Finedigital be liable for incidental or consequential damages relating to or resulting from the use of this device or any of its parts.

Finedigital is not liable for the costs of installing and removing the device and its accessories regardless of the warranty period.

FINE
DIGITAL

7th Floor, Fine Venture Bldg., 41, Seongnam-daero 925 beon-gil, Bundang-gu, Seongnam-si, Gyeonggi-do, 13496 Rep. of KOREA

www.finevu.com/en | Customer Support : support@finedigital.com | Made in Korea



FINE Vu

www.FineVu.com/en

FineVu Customer Center +82-31-788-8800

This manual describes the features of the product necessary to use it.