

FINE VU

GX1000

FineVu GX1000 User Manual

Please be sure to read the 'Safety and Precautions' before using the product, and use it correctly to prevent accidents or dangers.
(Menu screens and other illustrations in the user manual may differ from the actual product.)



Thank you for purchasing the FineVu Dashcam.

We always strive to get closer to our customers.

This user manual contains information on how to use and operate the GX1000 Dashcam.

Please be sure to fully read and understand this manual before using the GX1000 Dashcam.

Please also note that this manual may include technical or editorial errors or omissions.

In addition, the performance specifications of the GX1000 Dashcam are subject to change without notice.

Warranty and Support

- The website address is <http://www.finevu.com/en>.
- You can download the latest firmware and the user manual through the website.
- No warranties, including implied warranties, are provided for any kind of sales or conformance, other than in the form permitted by FINEDIGITAL Inc.

Copyright and Trademarks

- This manual is protected by copyright law, and all rights are legally protected.
- Except as permitted by copyright law, no part of this manual may be reproduced, copied, modified or translated without the prior written consent of FINEDIGITAL Inc.

Certificate

This device has passed KS C9990 (anti-disruption test on actuators of automobiles and internal combustion engines).

Sellers or users should note that this device is registered for electromagnetic compatibility, which aims to protect functions related to car operations and drivers, passengers and other car users from electromagnetic waves.

- Device name (model): Drive recorder (GX1000)
- KC certification number: R-R-FDK-FineR049
- Wi-Fi dongle KC: MSIP-CRI-JVS-CF-WU715N
- Trade name of certified person: FINEDIGITAL Inc.
- Manufacturer/Country of manufacture: FINEDIGITAL Inc./South Korea
- A/S contact: ☎ +82-31-788-8800

Safety and Precautions

Symbols	04
Warning	05
Note	06
Precautions for Use	07

Names of Components and Parts

Components - Optional Accessories	08
Names of Parts - Main Body & Front Camera	09
Names of Parts - Rear Camera	10
	11

How to Install

Inserting the Micro SD Card	12
Removing the Micro SD Card	12
Attaching the Cradle	13
Detaching the Cradle	13
How to Install the Front Camera	14
How to Install the Rear Camera	16

Key Product Features

Key Product Features	18
----------------------	----

How to Use

REC Button & Functional Description	19
VOL Button & Functional Description	21
Wi-Fi Button & Functional Description	22
GPS LED Status Description and Recording	22
Folder Configuration	23
Recorded Video File Name	23

How to Use FineVu Wi-Fi APP

Installation & Connection	24
Functional Description	29
View Realtime Video	30
Video Player Description	31
Setting Mounting Angle	32
Watching Video	34
Video Player Description	35
Set Up	36
View All Events (connected)	46
View All Events (connected) Explanation	47
View All Events (disconnected)	48
View All Events (disconnected) Explanation	49
Updating Firmware from APP	50

How to use FineVu player

How to Install & Use	51
Recommended specifications for PC	52
View Recorded Video & Update Firmware on PC	53

Symbols



Warning

Provides important information related to the safety of the user. Failure to comply may lead to death or serious injury.



Note

Information provided for the safety of the user and the proper use of the product. Failure to comply may result in personal injury or property damage.



Information

Information provided for user convenience.

Safety and Precautions



Warning

Failure to comply with the following instructions may result in death or serious injury of the user.

Power

- Do not use damaged or altered power cables, and use only genuine products provided by FINEDIGITAL Inc. Use of an incorrect or damaged power cable may cause a safety accident such as fire, damage to the vehicle or injury.
- Do not use at a voltage other than the rated voltage. Use at an incorrect voltage may cause a safety accident such as fire, damage to the vehicle or injury.
- Do not arbitrarily connect the power cable to another device, as this may cause a fire or malfunction.

Installation

- Do not install in an environment with high humidity or highly combustible liquids or gases. Failure to observe this requirement may cause a fire.
- Do not leave in an environment with high temperature, such as in an enclosed car or in a place where it will be exposed to direct sunlight, for an extended period of time. Failure to observe this requirement may cause a fire or malfunction.
- Do not install in a place where it will interfere with the driver's view, as this may cause a vehicle accident.
- Please plug in the power, GPS, and video cables correctly. Failure to observe this requirement may cause a fire or malfunction.

Use

- Do not allow metal or flammable materials to enter the memory card slot or the place on the product where the power cord is inserted. Failure to observe this requirement may cause electric shock or fire.
- Do not operate the product with wet hands. This may cause electric shock.
- Do not leave the product or its accessories around infants or children, as the small accessories are a choking hazard.
- Do not cover the product with a cloth or blanket while it is operating. It may overheat and cause a fire or malfunction.
- Please do not operate the Dashcam while driving, as this may cause a vehicle accident.

**Note**

Failure to comply with the following instructions may cause personal injury or property damage to the user.

Installation

- Do not arbitrarily install a constant power supply, as this may cause a product or vehicle malfunction. Be sure to get help from a professional installation engineer.

Use

- Do not apply excessive force to the lens, lens cover, or the exterior of the camera. Failure to observe this requirement may cause a malfunction.
- Do not use the product with an awl or sharp object. Failure to observe this requirement may cause a malfunction.
- Using the Dashcam for an extended period of time may heat up the surface. Please be careful.
- Do not arbitrarily disassemble or alter the product. This may cause damage or data loss, so please request the A/S center for inspection and repair.
- Be careful not to cover the lens when filming.
- Changing the position of the camera while it is installed may result in poor contact.

Management

- Do not leave the product or its accessories around your pet. Foreign substances from pets may enter the product and cause malfunction.
- If the product is not in use for an extended period of time, do not leave the product unattended with the power cable connected. Failure to observe this requirement may cause a fire or malfunction.
- Do not move an operating product with the car power connector or cables plugged in. Failure to observe this requirement may cause fire or electric shock.



- To improve the performance of the product, the product specifications and contents of the user manual are subject to change without notice.
- This manual shall not be copied, in whole or in part, without permission.
- This company is not responsible for any data loss or product loss caused by a product malfunction in the event of an accident or in any other cases.

Precautions for Use

A Dashcam is an auxiliary device that takes images and records them in a storage device in specific situations when a vehicle is driving or parking. Please use it as a supplementary device to determine the circumstances of an accident. FINEDIGITAL Inc. is not liable for any damages arising from an accident, and will not provide support for any consequences resulting from an accident. Please read and understand the following before using the product.

If the recording file cannot be found:

- **Recorded videos are deleted over time**
Because it uses a storage device (Micro SD card) with a limited storage capacity, if the storage device exceeds the capacity during recording, the oldest videos will be deleted sequentially.
- **Sensitivity setting in the impact detection sensor**
Depending on the impact detection sensitivity setting in the product (normal, sensitive, insensitive, etc.), if the impact intensity is less than the set value, the impact image may not be stored in the event folder or the parking folder.
- **Voltage setting for vehicle battery**
When using the parking monitoring function, the Dashcam will continue to monitor the voltage of the vehicle's battery to protect the vehicle battery, and if the voltage of the vehicle battery drops to the voltage set in the Dashcam configuration, the power of the Dashcam will be automatically cut off and the Dashcam will stop operating.

How to deal with an accident

- In the event of an accident, turn off the Dashcam power and remove the Micro SD card. If you continue to use it without removing the Micro SD card, the recorded video may be deleted over time. If it is difficult to remove the Micro SD card, you may turn off the power from the Dashcam.
- Please back up the accident video using your PC.
- Do not connect the removed Micro SD card to your smartphone. When connecting a Micro SD card to a smartphone, the recorded video may be lost due to the file structure change by the smartphone.

How to clean and store

- If there is a foreign substance on the lens, wipe it clean with a soft cloth (cotton).
- To record high-quality images, please avoid touching the lens with your hands or contacting other objects.
- If there is a foreign substance in the terminal of the main body, do not take it out or remove it using a tool; please contact the A/S center for repair.
- If the product is not in use, please keep it indoors, separately from the vehicle.
- Be sure to disconnect the power before storing.
 - Avoid humid environments and keep the product sealed as much as possible.
 - Be sure to remove the memory card and keep it in order to maintain the memory card's performance.

Product composition

Components

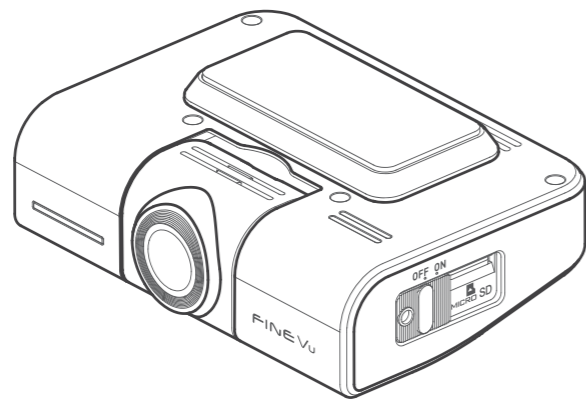

Front Camera

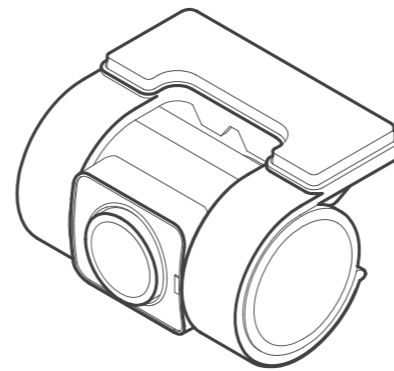

Rear Camera

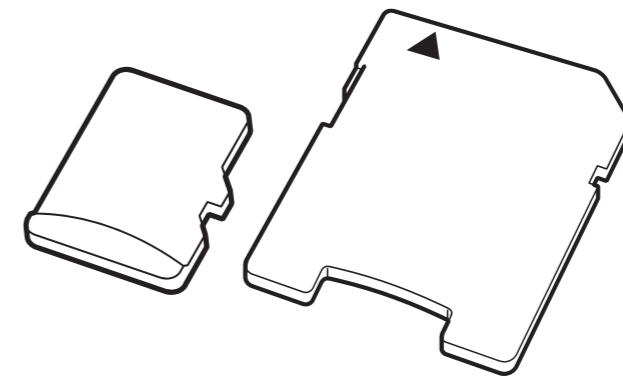

Micro SD Card & Adapter

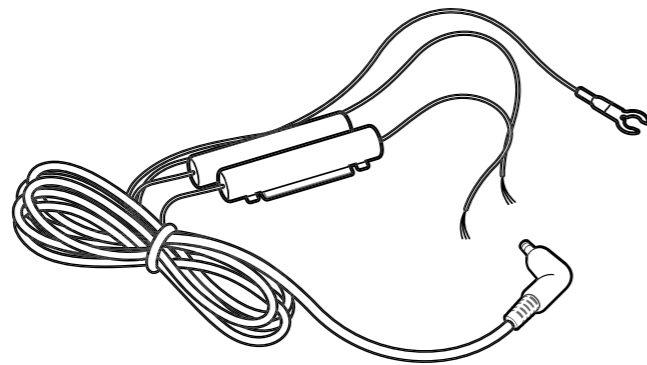

Power Cable

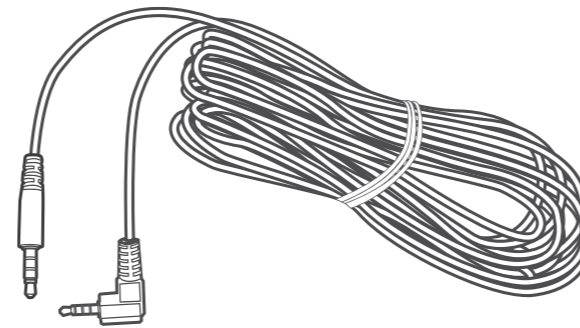

Rear Cable

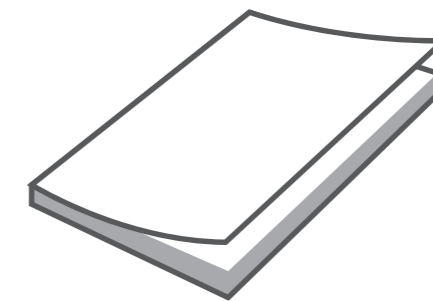

User Manual



- The components of this product may be changed without prior notice to improve product performance.
- The warranty period for the Micro SD card is 6 months.

Optional Accessories

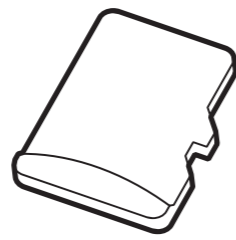

High Capacity Micro SD Card

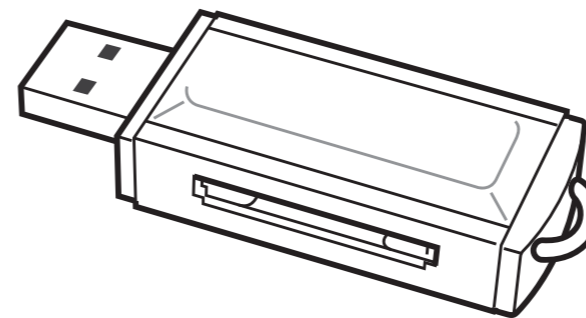

USB SD Card Reader



All optional accessories are available for purchase on the FineVu website.

Name of Parts

Front Camera

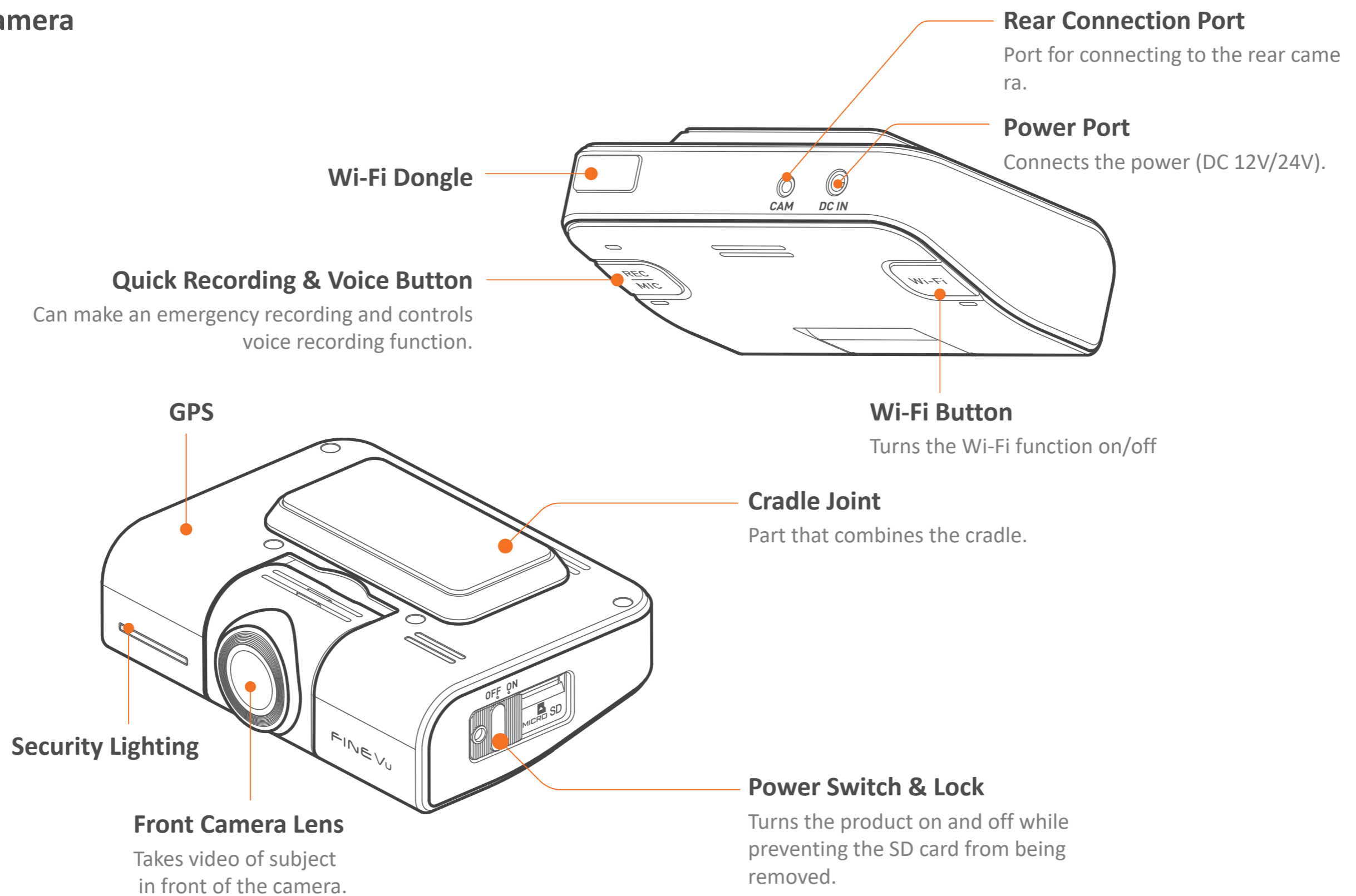

Rear Camera

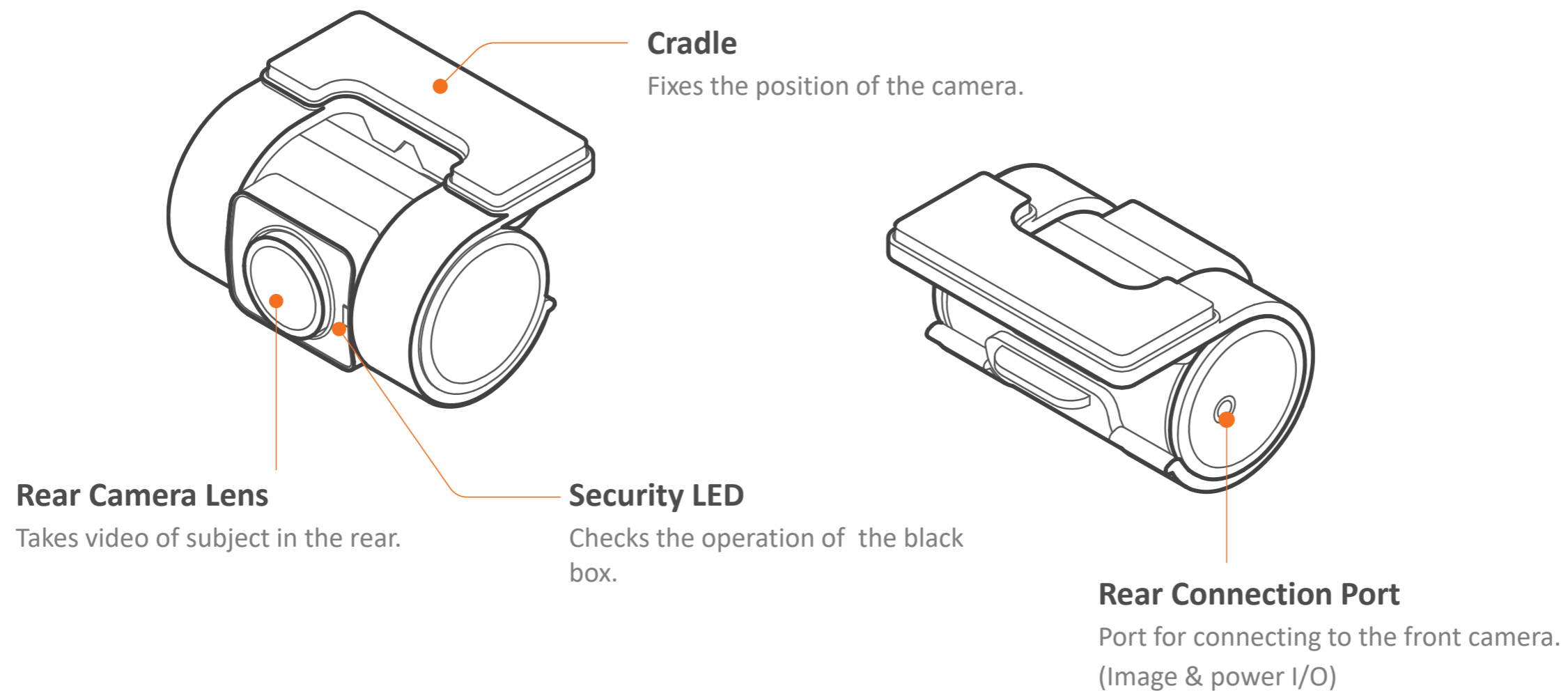

- Connecting a cable other than the rear-only cable to the rear connection port may cause damage.
- Security lighting is set to OFF by default. User settings must be adjusted to use the security lighting.

How to Install

Inserting the Micro SD Card

1. Open the power switch & lock.
2. Check the insertion direction of the Micro SD card.
3. Insert the Micro SD card until it makes a 'click' sound.
4. Close the power switch & lock.

Removing the Micro SD Card

1. Open the power switch & lock.
2. Press the inserted Micro SD card.
3. When the Micro SD protrudes from the product, remove it by hand.

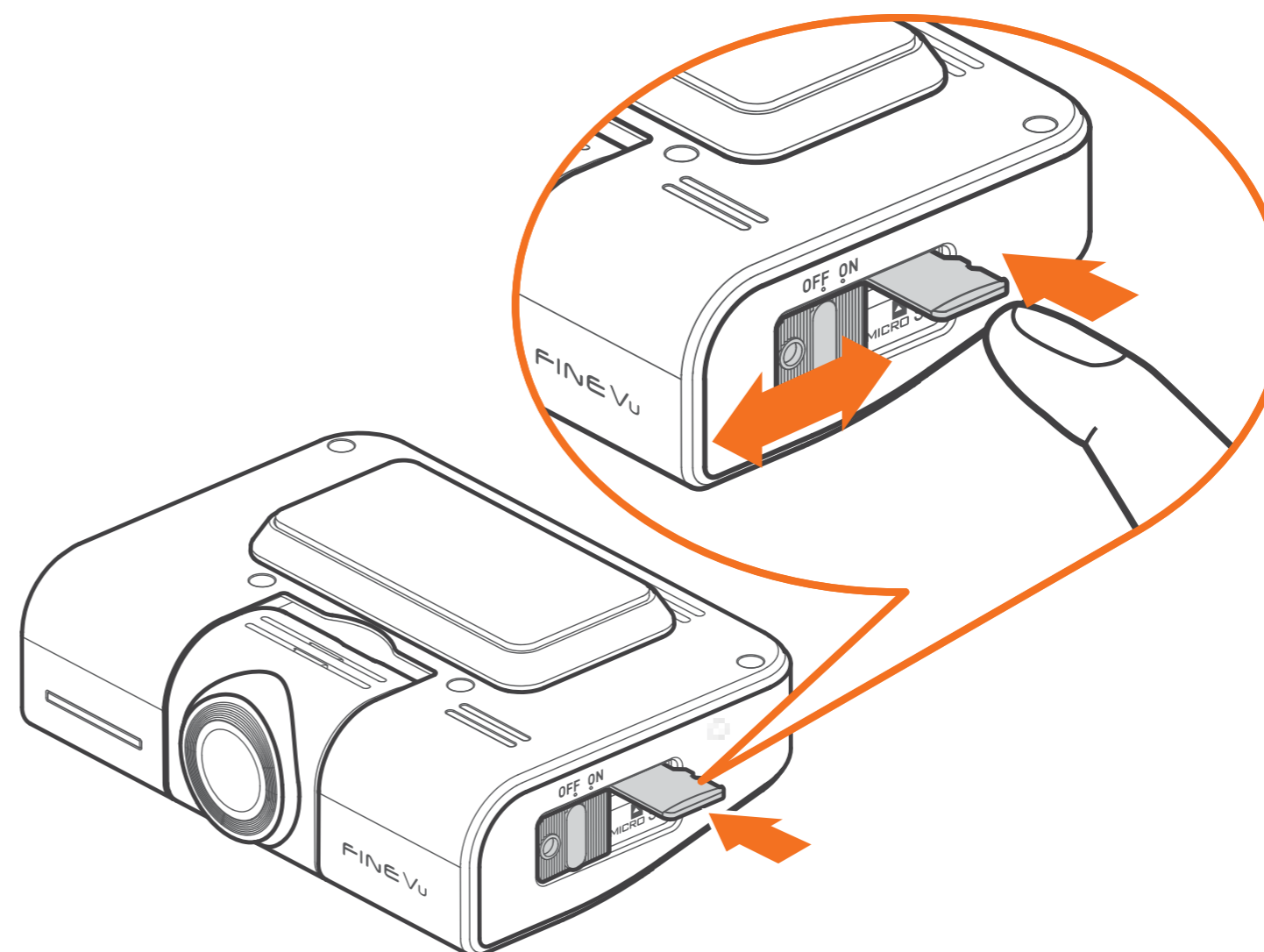

- The power switch & lock is a device that turns the power on/off and prevents the Micro SD card from being pulled out at the same time.
- When you open the power switch & lock upward, the power to the product will turn off.



- Please make sure to use a genuine FineVu memory card. If a non-genuine memory card is used, compatibility and normal operation cannot be guaranteed.
- Carefully observe the direction in which the Micro SD card is inserted. If the Micro SD card is inserted incorrectly, the memory card slot of the product or the Micro SD card may be damaged.
- Please regularly back up important videos to a separate storage device.

Attaching the Cradle

1. Align the cradle part with the arrow ① and insert it into the cradle groove on the main body of the product.
2. While inserting it into the groove, push the cradle in the direction of arrow ② until it makes a 'click' sound to fix it on the product.

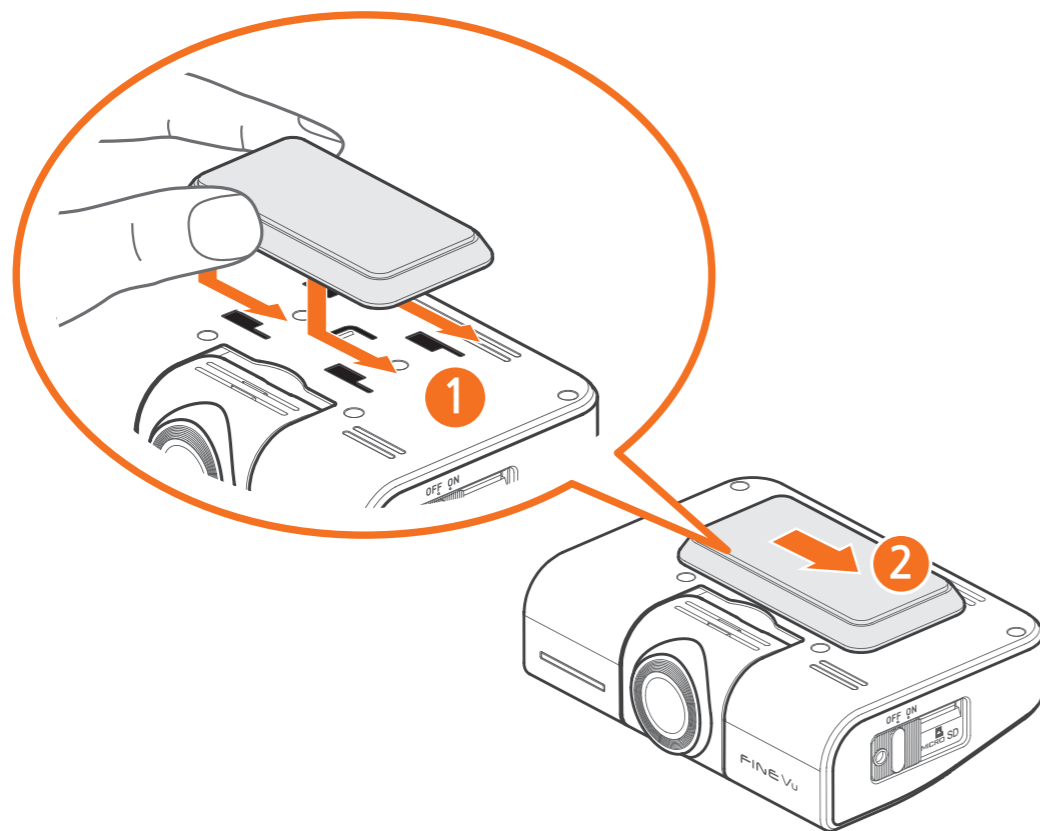

Detaching the Cradle

1. Push the cradle in the direction of the arrow ① until it makes a 'click' sound.
2. After pushing it, separate the cradle in the direction of the arrow ②.

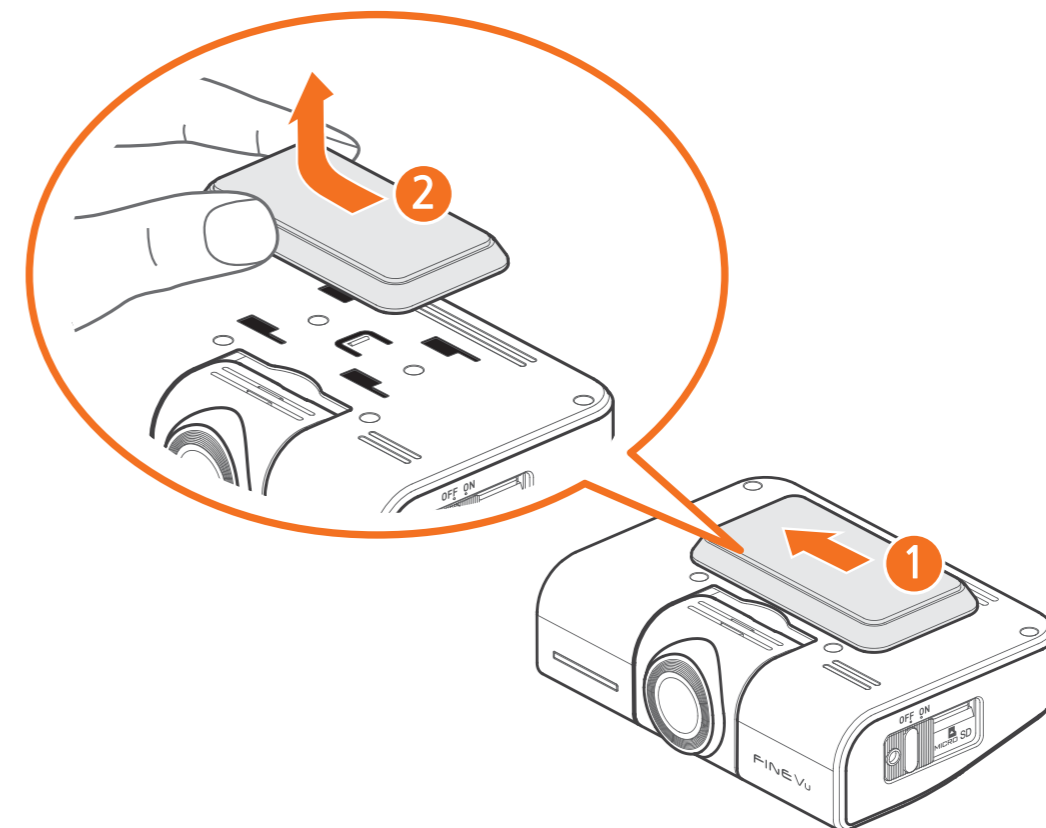

When attaching the cradle, please align the left and right directions of the cradle well. If you try to attach it in the wrong direction, the product may be damaged.

How to Install the Front Camera

1. Decide where you want to install the product.

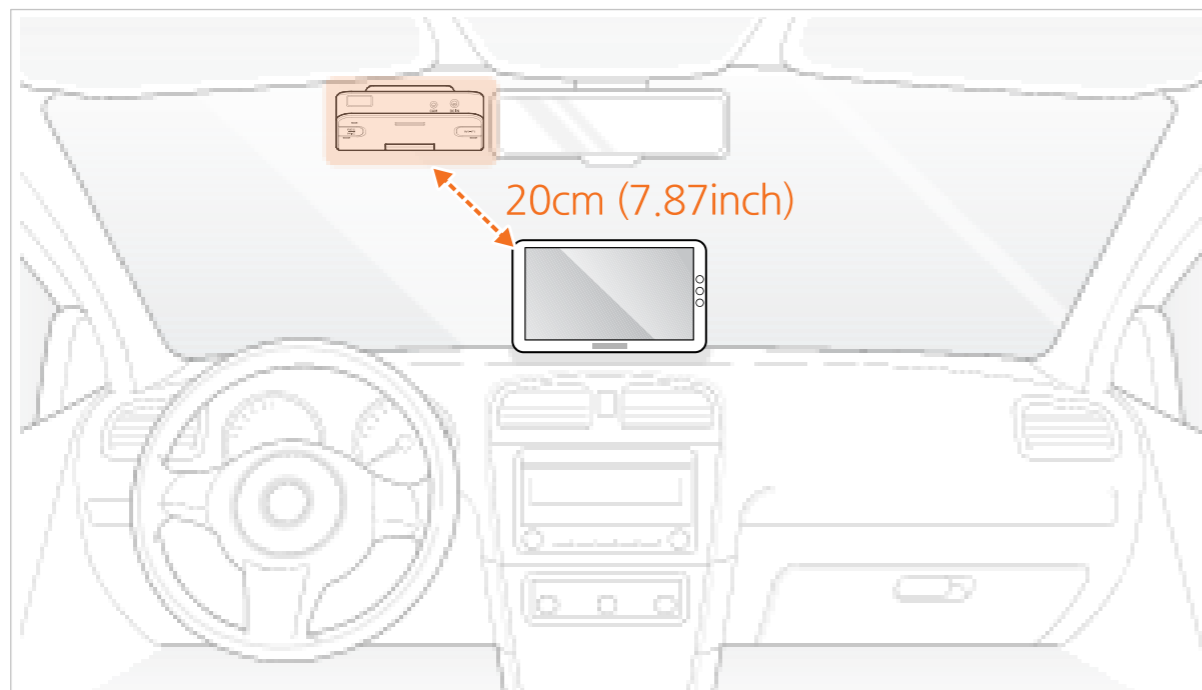

- Please set the installation location of the product at least 20cm away from other electronic devices such as the navigation system.
- Install in a location where it will not interfere with the driver's view.

2. Remove the protective film from the front camera.

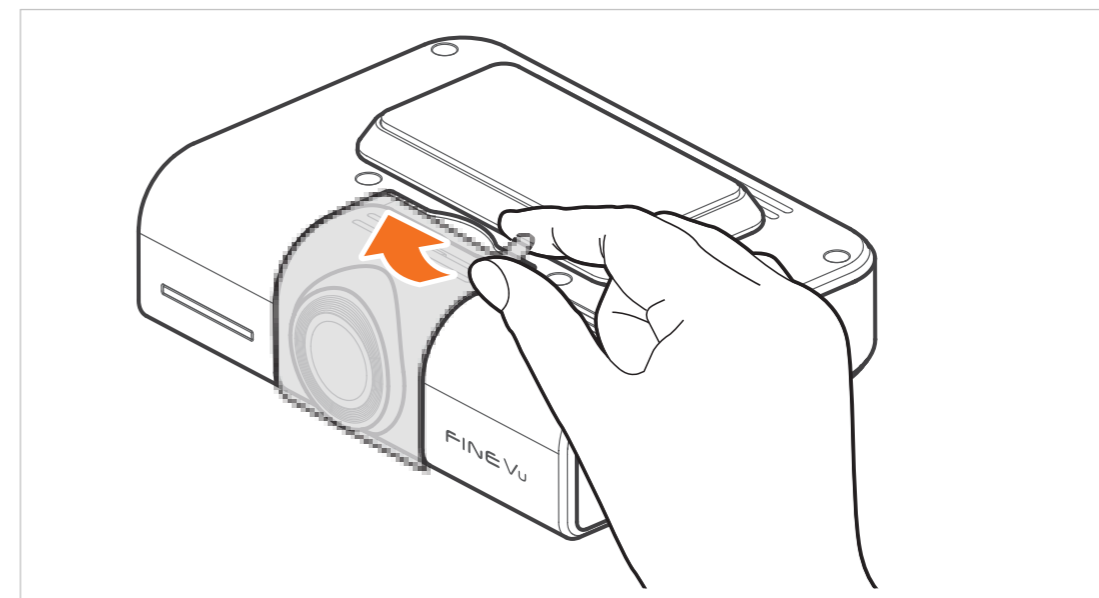

3. Peel off the protective film from the tape for attaching the cradle.

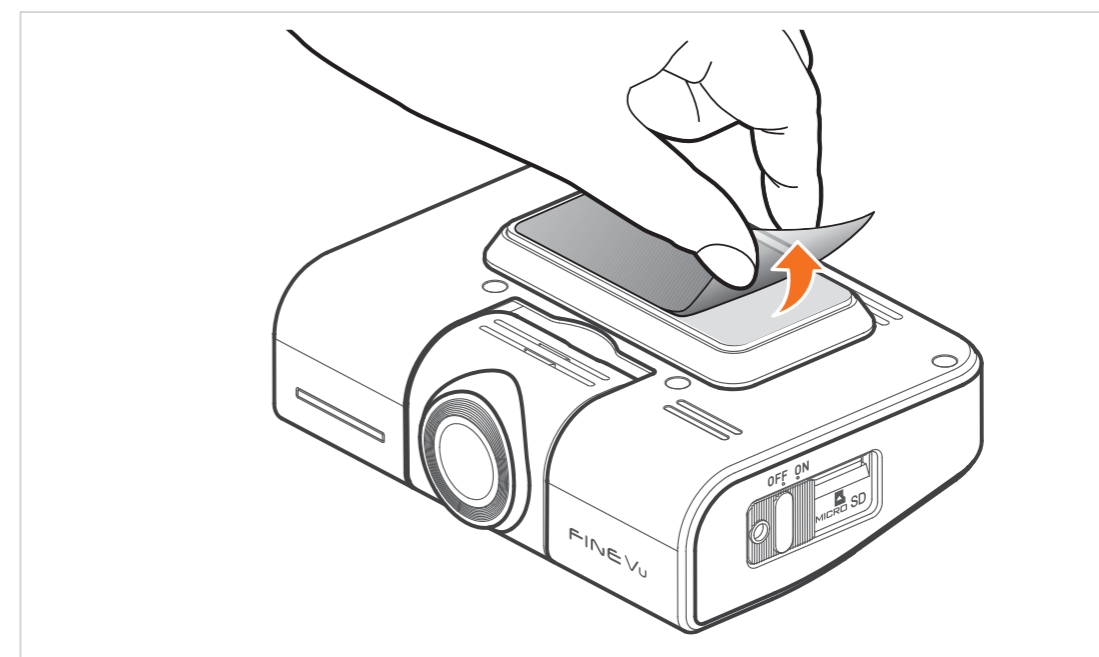

4. Attach the cradle from which the protective film has been removed to the location where you want to install the product.

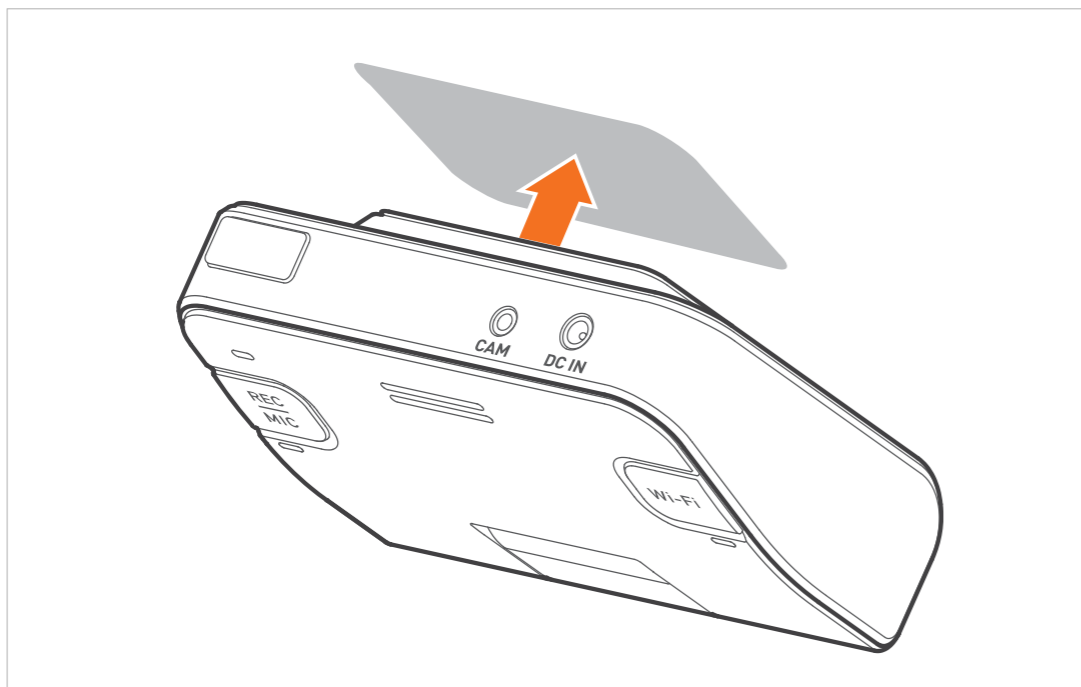

5. Connect to the constant power cable connected to the fuse box.

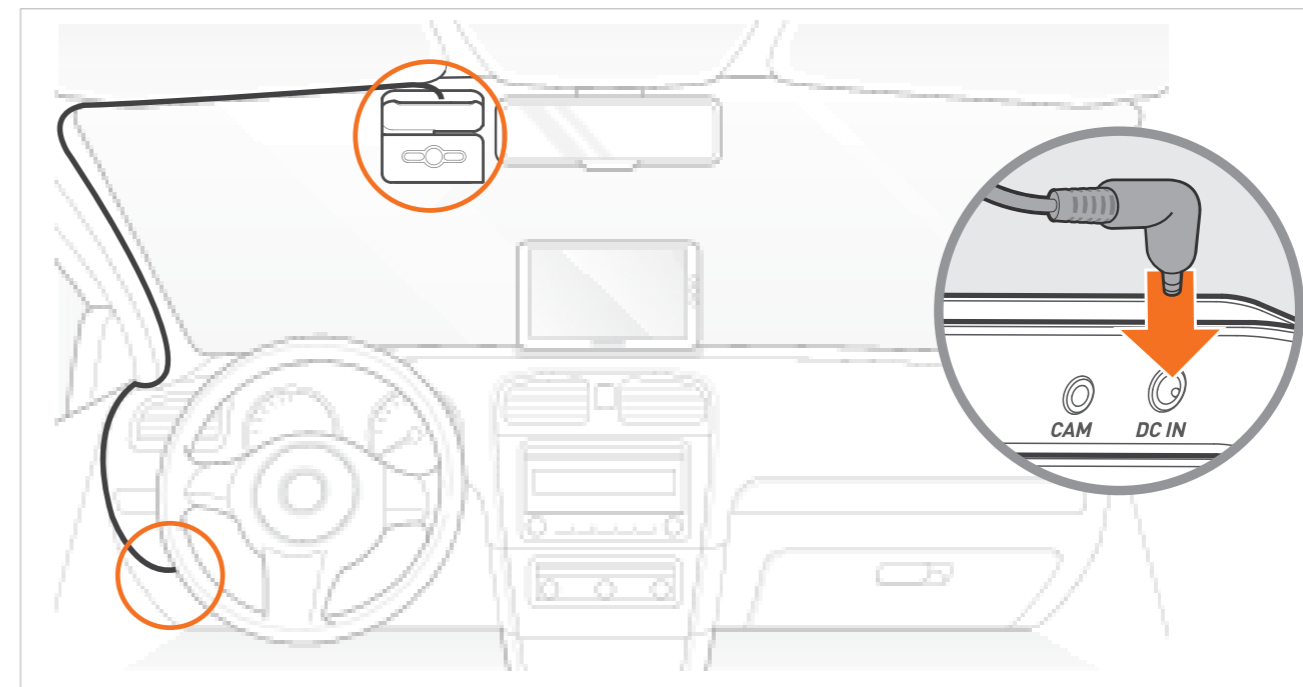

How to Install the Rear Camera

1. Decide where you want to install the product.

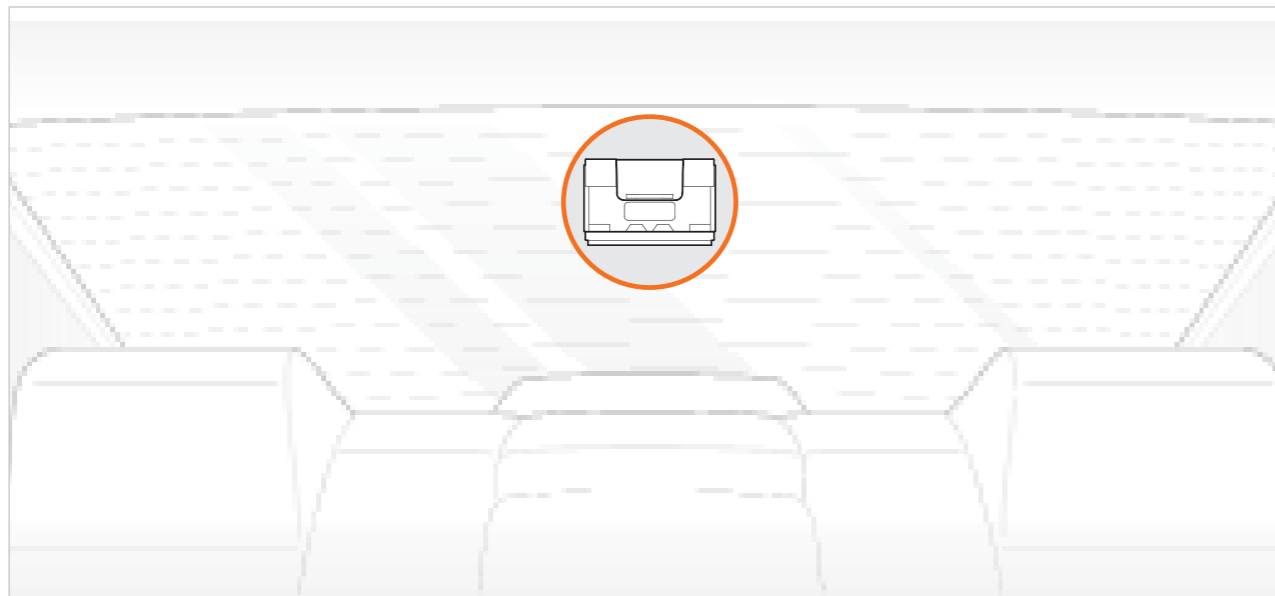

· Install in a location where it will not interfere with the driver's view.

2. Remove the protective film from the rear camera.

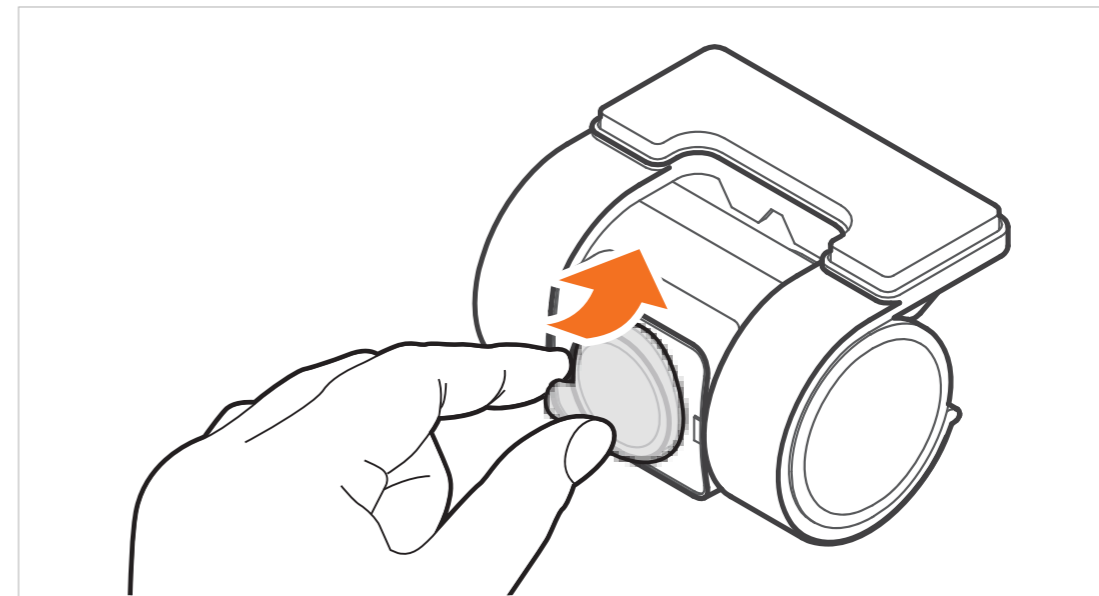

3. Peel off the protective film from the tape to attach the cradle.

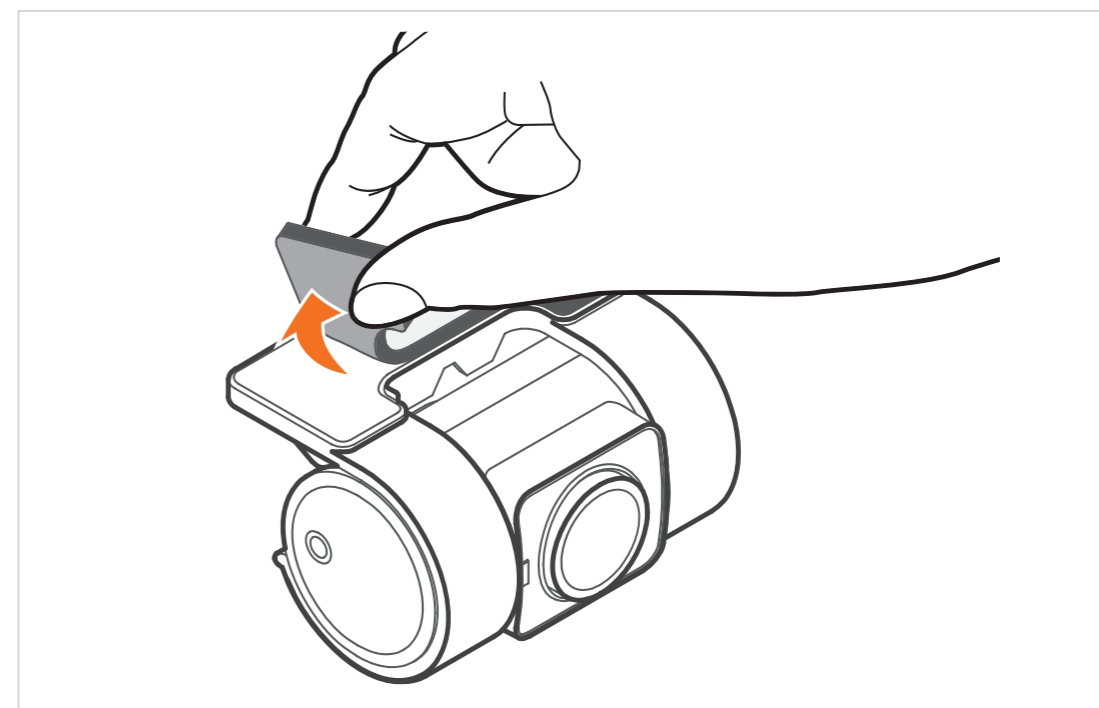

4. Attach the rear camera to the location where you want to install it.



5. Connect the rear camera with the rear-only cable.

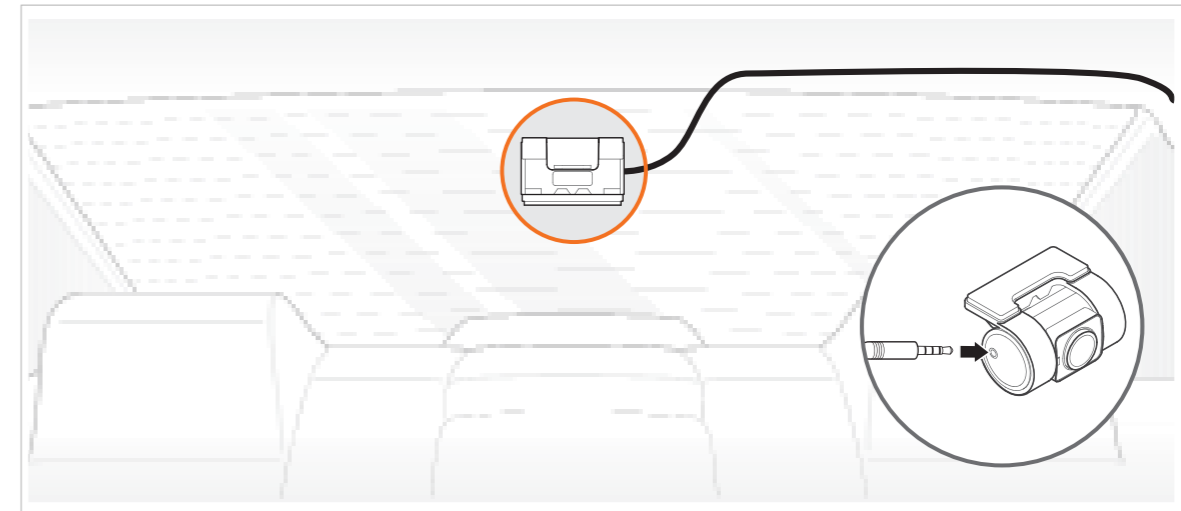

6. Connect the rear-only cable to the front camera of the Dashcam.

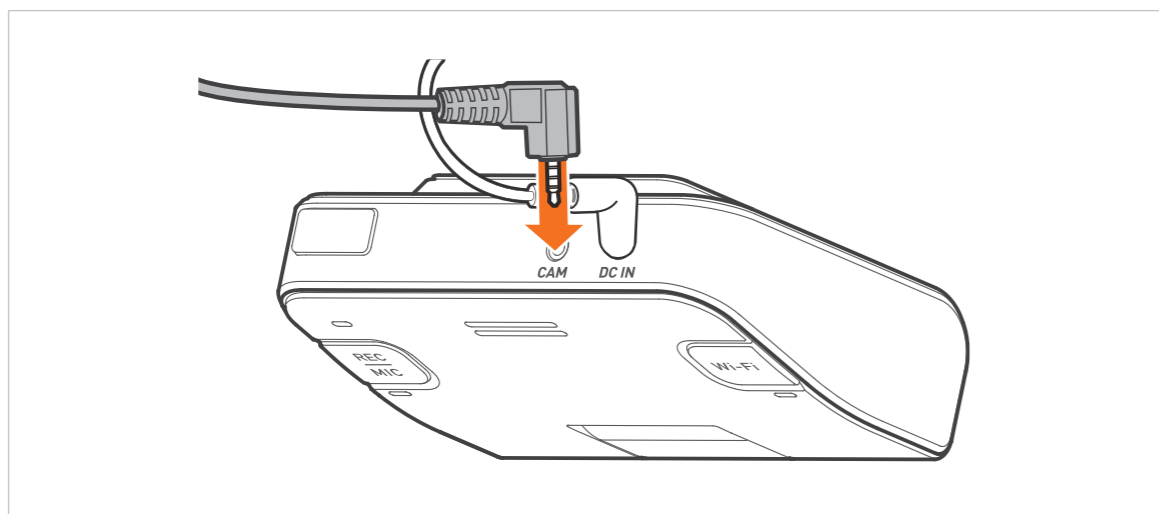

7. When installation is complete, adjust the angle of the recording video by connecting the FineVu Wi-Fi APP.

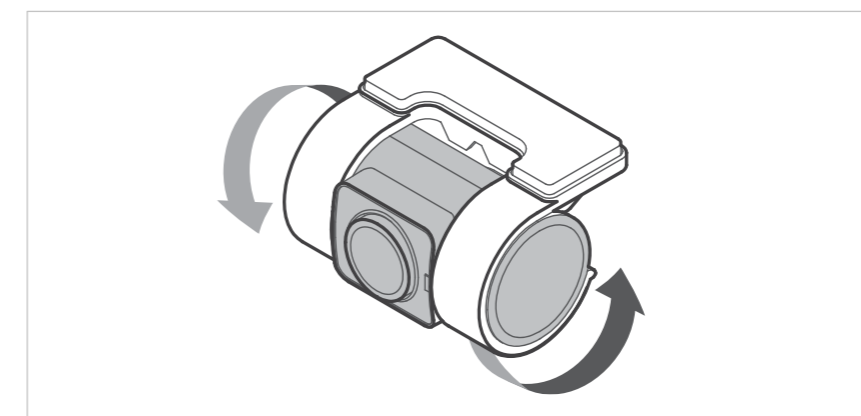

- Please use only genuine accessories provided by this company.
- Using third-party products may cause damage to the product, fire, or electric shock due to voltage differences.
- You have to use constant power when using parking recording. As constant power has to be connected separately except with some vehicle models, get the help of an expert in the installation branch. (You are recommended to install a constant power supply to prevent the vehicle's battery from being discharged.)
- When connecting constant power cables, pay attention to the connected position of each wiring.
- Do not arbitrarily cut or alter the enclosed genuine constant cables.

Key Product Features

STARVIS	<p>Equipped with SONY Exmor R STARVISTM image sensors Equipped with SONY Exmor R STARVIS image sensors, which provide brighter and cleaner image quality than regular CMOS sensors even at night.</p>
QUAD HD 30fps	<p>High-resolution image recording With a high-performance image sensor and high-quality lens, it records front/rear in QUAD HD (2560x1440p@30fps).</p>
FineVu Wi-Fi App	<p>FineVu Wi-Fi dedicated App You can easily set up the Dashcam and check the video using the FineVu Wi-Fi App.</p>
HDR	<p>HDR support FineVu's unique tuning technology enables clear and vivid recording in diverse illuminance conditions, including backlighting, night driving, entering and exiting tunnels and parking lots.</p>
Auto Night Vision	<p>Equipped with auto night vision Offers improved identification of objects with bright images, and minimizes deterioration in image quality when shooting in low light or at night.</p>
ADAS & Safe driving 2.0	<p>ADAS & Safe Driving 2.0 Supports ADAS/Safe Driving Assistant 2.0 function. This works only when a GPS signal is available.</p>
Smart Time Lapse	<p>Driving and parking time lapse recording In driving and parking mode, you can quickly check the recorded video with Smart Time Lapse settings. (In the event of an impact in driving and parking mode, it records at the standard 30fps.)</p>
Power Saving Mode	<p>Equipped with power saving mode With FineVu's unique low-power technology, it records safely even while parked for an extended period.</p>

How to Use

LED color and operation description























Image	LED color	LED status	Mode	Operation Description	Button
 Security LED	White	 OFF	-	<ul style="list-style-type: none"> Power OFF status 	-
		 Dimming	Driving & Parking Mode	<ul style="list-style-type: none"> Shooting status in driving mode & parking mode, where the LED turns on and off slowly over about 4 seconds. 	-
		 Blink	Driving & Parking Event	<ul style="list-style-type: none"> If an event occurs during driving mode, the LED will blink while switching to event recording. If an event occurs during parking mode, the LED will blink while switching to event recording. 	-
 LED A	Green	 Blink ON	Mic ON	<ul style="list-style-type: none"> Switching from voice recording OFF status to voice recording ON status 	Mic ON : Press and hold button A for 1.5 seconds
		 ON	Driving & GPS Receiving	<ul style="list-style-type: none"> During driving mode, the green LED turns ON. When receiving GPS, the green LED turns ON. 	-
	Red	 Blink	Driving Impact Manual Recording Parking Monitoring Parking Event	<ul style="list-style-type: none"> In the event of an impact during driving mode, the red LED will blink. During manual recording, the red LED will blink. If there is an impact or if a motion is detected while in parking mode, the red LED will blink. 	Manual Recording : Briefly press button A
	Yellow	 Blink OFF	Mic OFF	<ul style="list-style-type: none"> Press and hold button A for 1.5 seconds Switching from voice recording ON status to voice recording OFF status 	Mic OFF : Press and hold button A for 1.5 seconds

Image	LED color	LED status	Mode	Operation Description	Button
 <p>Wi-Fi LED B</p>	Blue	 OFF	Wi-Fi OFF	<ul style="list-style-type: none"> • Power OFF status • Wi-Fi OFF status 	-
		 Blink	Dongle Not Present	<ul style="list-style-type: none"> • Dongle not present; waiting for connection 	-
		 ON	Wi-Fi ON	<ul style="list-style-type: none"> • When the Wi-Fi function is ON, the LED turns ON. 	Wi-Fi ON : Briefly press button B
		 Blink	Waiting for Wi-Fi Connection & Wi-Fi Initialization	<ul style="list-style-type: none"> • While waiting for the Wi-Fi connection or initializing the Wi-Fi setting, the LED will blink 	Wi-Fi Initialization : Press and hold button B for 3 seconds
 <p>REC MIC LED A + Wi-Fi LED B</p>	Magenta & White	 Blink	Firmware Update	<ul style="list-style-type: none"> • When updating the firmware, the white LED will blink. 	-
		 Blink	Memory Format & Reset	<ul style="list-style-type: none"> • When formatting memory or initializing settings, the Magenta LED will blink. 	Memory Format : Press and hold both button A and button B simultaneously for 3 seconds
	White	 ON → OFF	Booting up	<ul style="list-style-type: none"> • When booting up, both LED A and B turn on at the same time. 	-

Recording Folder Configuration

Image	Driving Recording (driving time lapse)	Driving Impact	Parking Impact	Parking Motion (parking time lapse)	Quick Recording
Folder Name	 Normal	 Event	 Parking	 Motion	 Camcorder

Recorded Video File Name

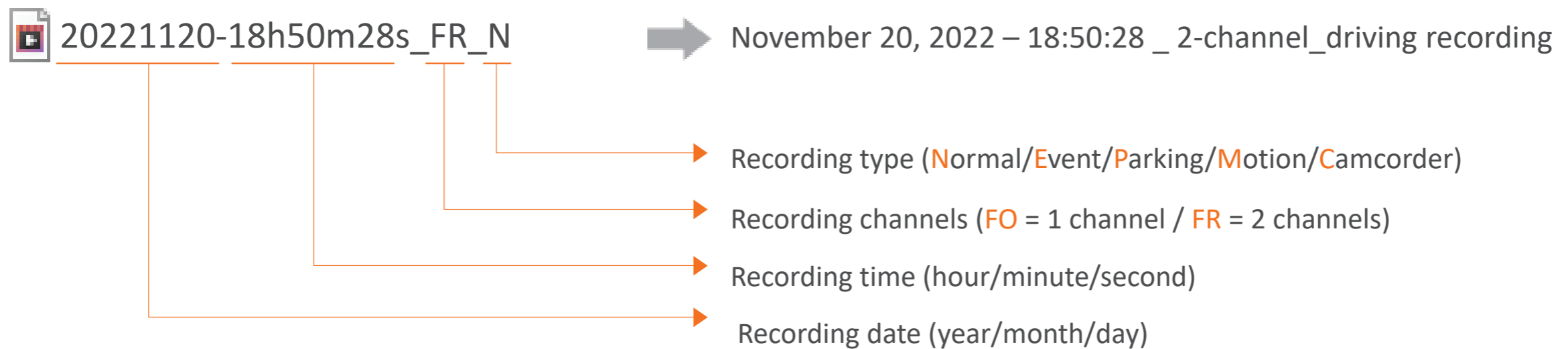



- Only images related to impact detection and motion detection are recorded while parking. (Time lapse set separately)
- Parking motion detection recording and parking time lapse recording cannot be used simultaneously.
- Time lapse recording does not record audio.

How to use the FineVu Wi-Fi App

Installation & Connection

- **To connect for the first time:**

1. Download the 'FineVu Wi-Fi' APP from the 'Google Play Store ()' or the 'App Store()' depending on your smartphone type.
2. Activate the Wi-Fi function by pressing the  Wi-Fi button on the main body of the Dashcam.
3. Run the 'FineVu Wi-Fi' app installed on your smartphone.
4. When the Wi-Fi function turns on, connect the Wi-Fi of your smartphone to the Wi-Fi network starting with 'FineVu_GX1000'.
(The initial password is '12345678')
5. When the Wi-Fi is connected between your smartphone and the product, go back to the app.

- **To reconnect:**

1. Run the 'FineVu Wi-Fi' APP installed on your smartphone.
2. Activate the Wi-Fi function by pressing the  Wi-Fi button on the main body of the Dashcam.
3. Press the 'Connect to Dashcam' button in the APP to connect to the Wi-Fi network starting with 'FineVu_GX1000'.



- During Wi-Fi connection with the Dashcam, your smartphone will go offline, and data will be blocked temporarily. When you disconnect, it will be restored to its original state.

Connecting

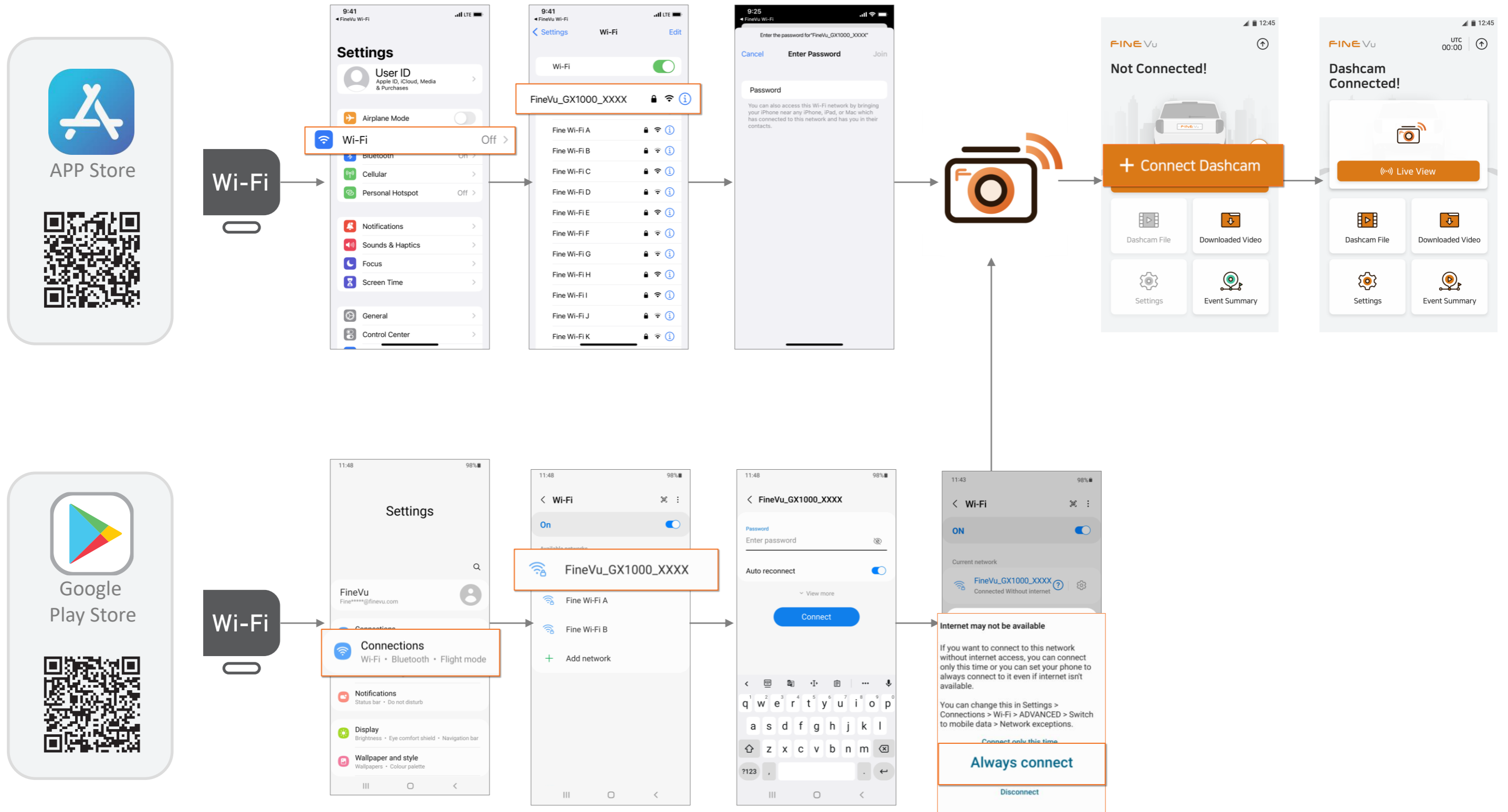

Description of Functions

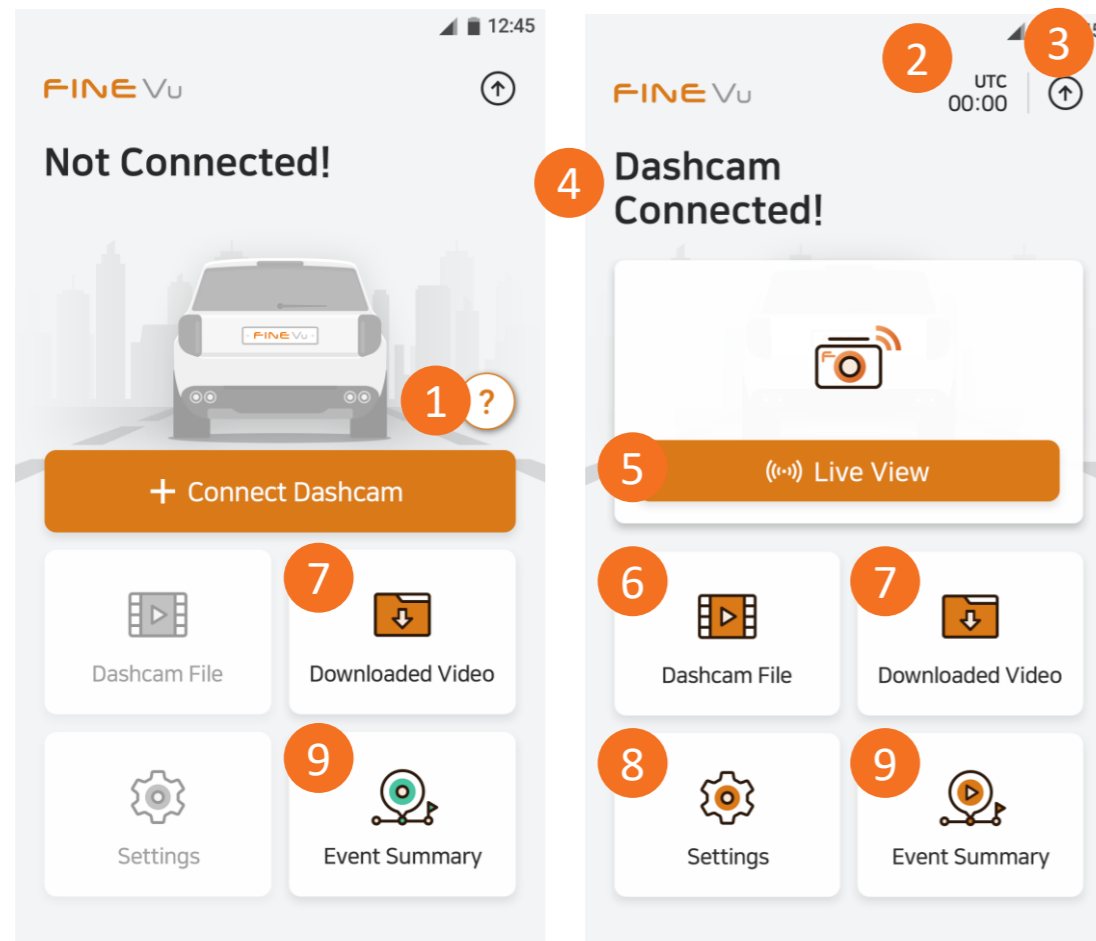

No.	Description of Functions
①	You can check the help for 'Connect to Dashcam'. (When connected to the Dashcam, the button will disappear.)
②	When connected to the Dashcam, it shows UTC time information, where you can change the UTC settings.
③	You can check the product name, and the current and latest versions of the App, Speed Camera, dashcam language file, and firmware. You can also change the Speed Camera region and the dashcam language.
④	Shows current connection status with the Dashcam.
⑤	You can check the real-time video of the connected Dashcam. (When disconnected, the '+Connect to Dashcam' button will be provided.)
⑥	You can check the recorded video of the connected Dashcam.
⑦	You can check and share the downloaded videos.
⑧	You can change the settings of the connected Dashcam.
⑨	This feature varies depending on whether it is connected to the Dashcam or not. (See detailed information in 'How to Use FineVu Wi-Fi APP > Event Summary (when connected) or the Event Summary (when disconnected)')



When the Dashcam is not connected, certain functions such as real-time images and Dashcam files are disabled.

View Real-Time Video

1. Run the 'FineVu Wi-Fi' APP to connect with the Wi-Fi of the Dashcam. (See the 'How to Use FineVu Wi-Fi APP > Installation & Connection')
2. On the main screen, tap the 'Live View' button that provides Realtime Video.
3. This offers a number of functions including front and rear real-time video, mounting angle setting, and capture.

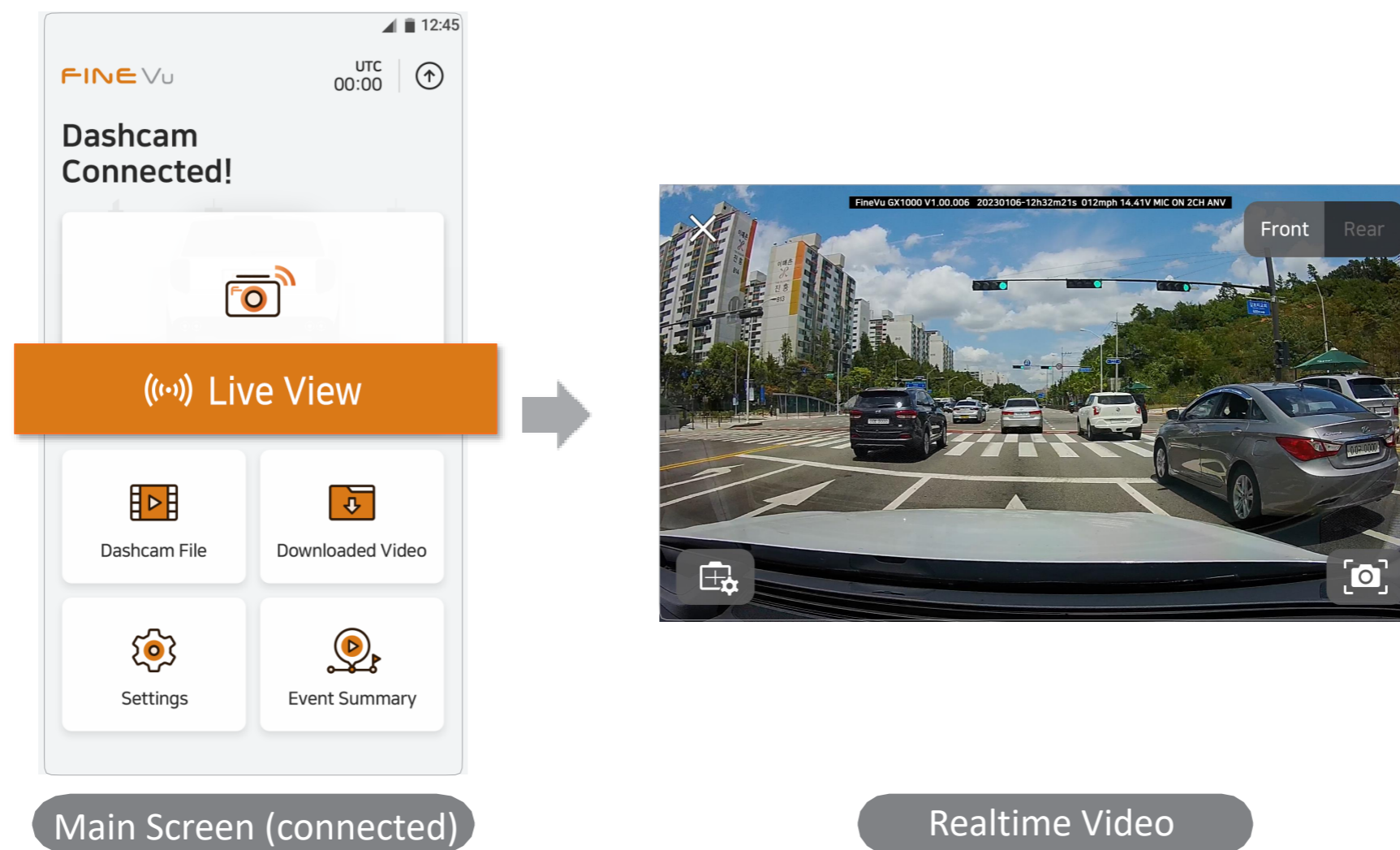

When the Dashcam is not connected, these functions will not be provided.

Video Player Description

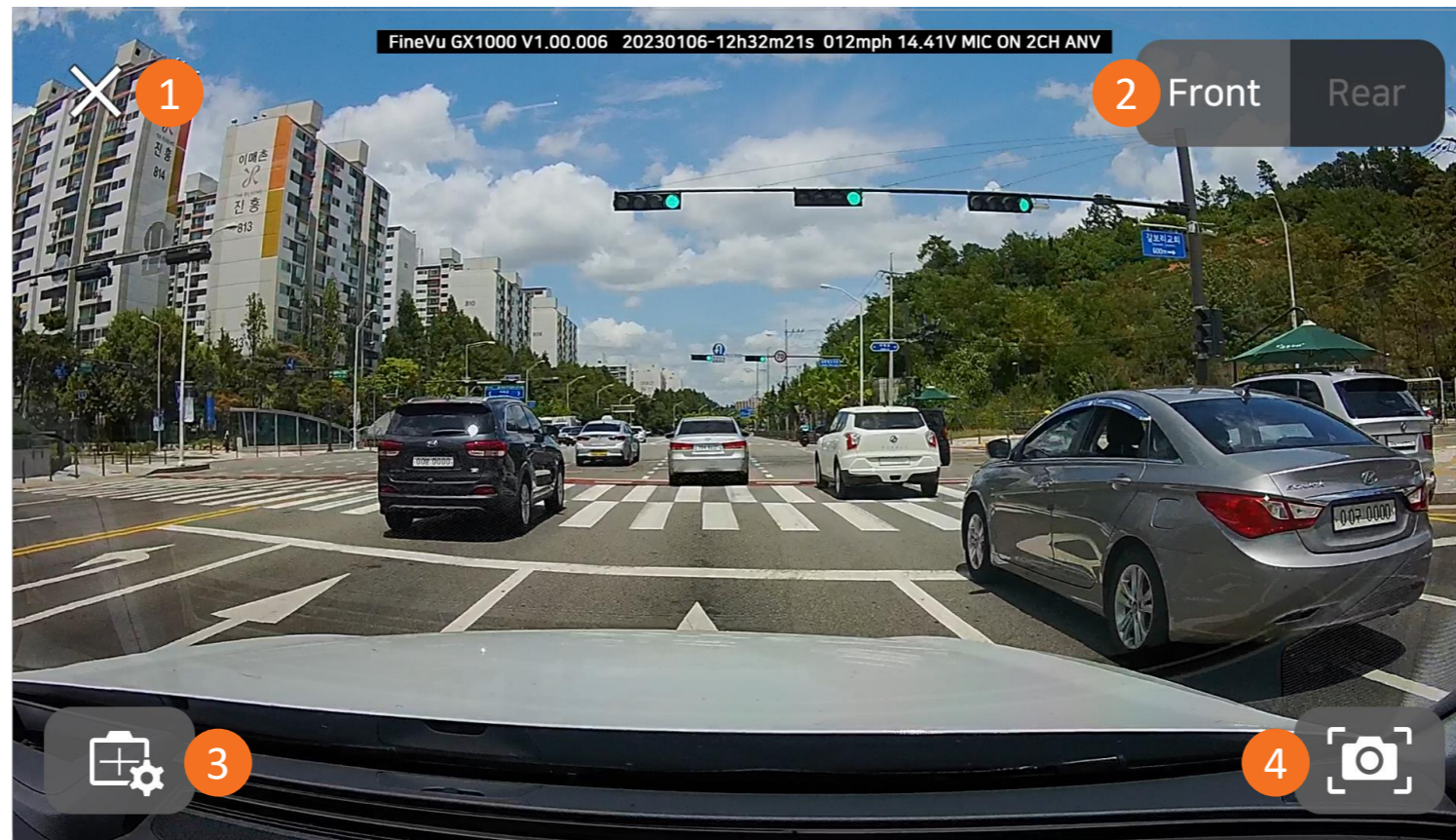

No.	Name	Functional Description
①	Close	Close the real-time video and go back to the main screen.
②	Front/Rear Switching	You can choose either front or rear real-time video.
③	Setting the Mounting Angle	You can set the mounting angle. (See the 'How to Use FineVu Wi-Fi APP > Mounting Angle Description')
④	Capture	Captures the current image as of the moment you tap it.

Setting Mounting Angle

1. Launch the 'FineVu Wi-Fi' APP to connect with the Wi-Fi of the Dashcam. (See 'How to Use FineVu Wi-Fi APP > Installation & Connection')
2. On the main screen, tap the 'Live View' button that provides Realtime Video.
3. On the Realtime Video screen tap the  button.

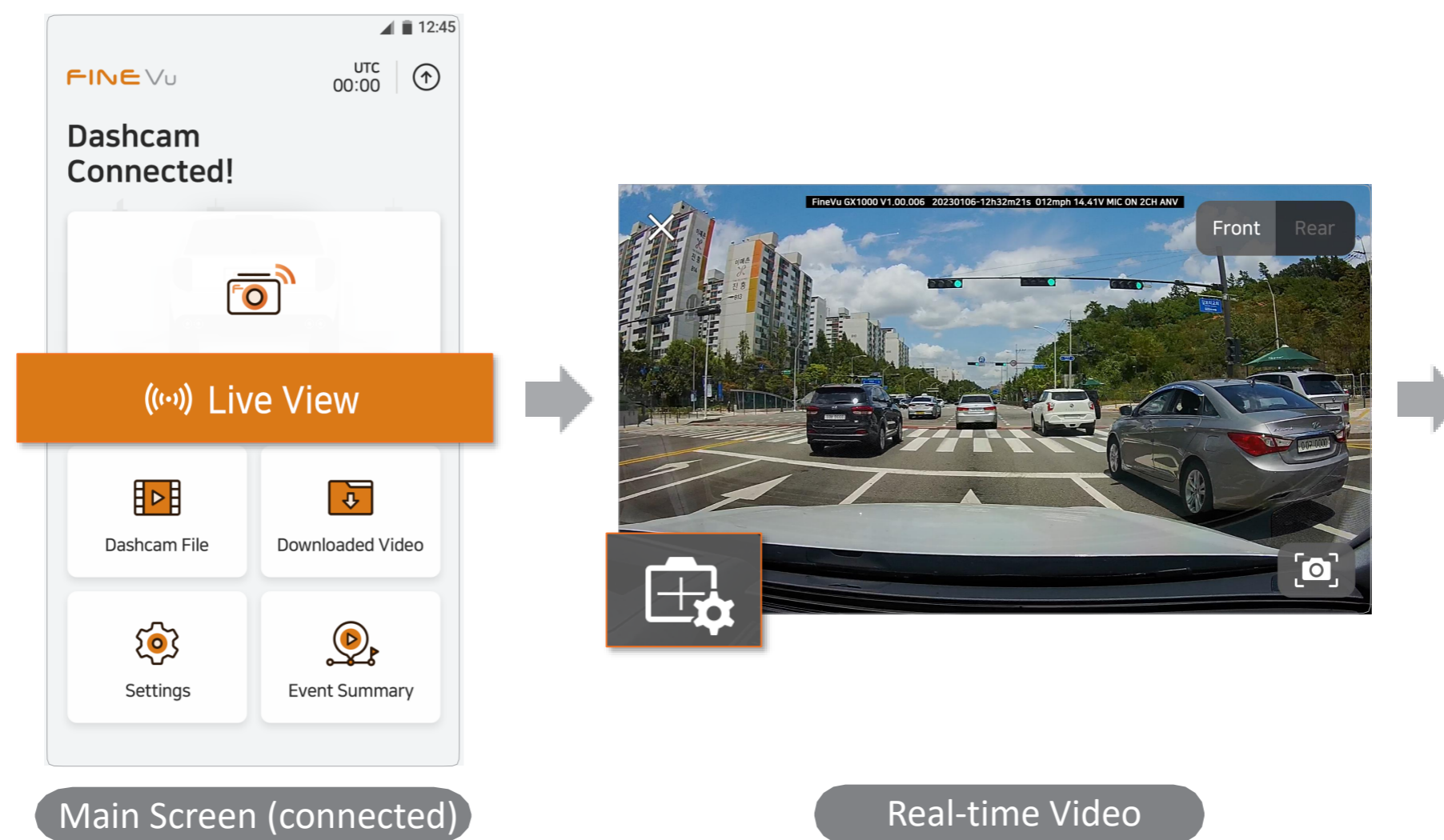

When the Dashcam is not connected, those functions are not provided.

4. Set the mounting angle in the correct sequence, referring to the screen below.

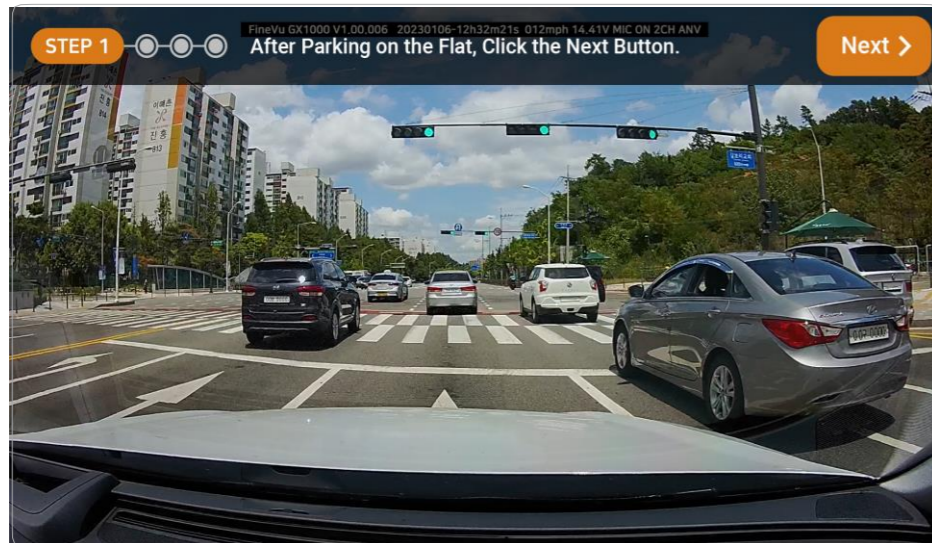

Step 1. Pull over the car, on a flat section of road, and press Next.



Step 2. Choose the appropriate vehicle type.

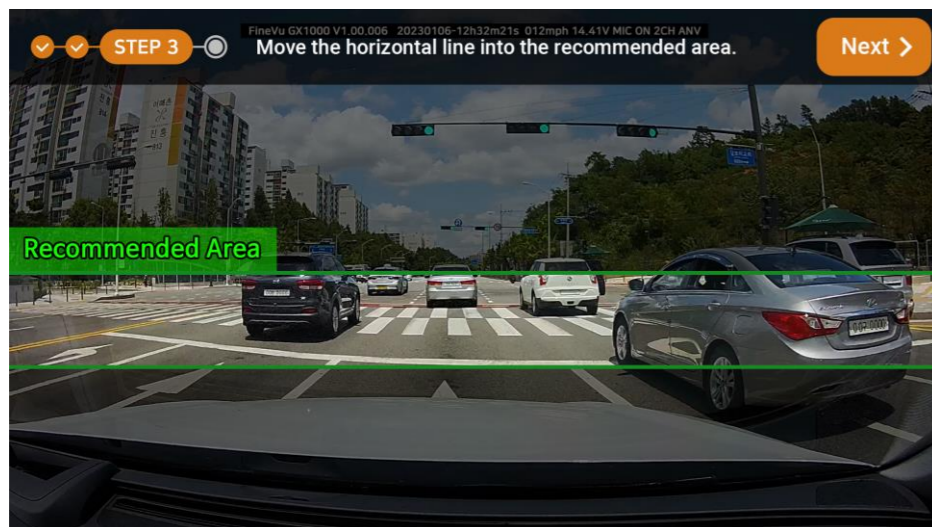

Step 3. Adjust the angle of the front camera to align the horizon into the green area provided on the APP screen.

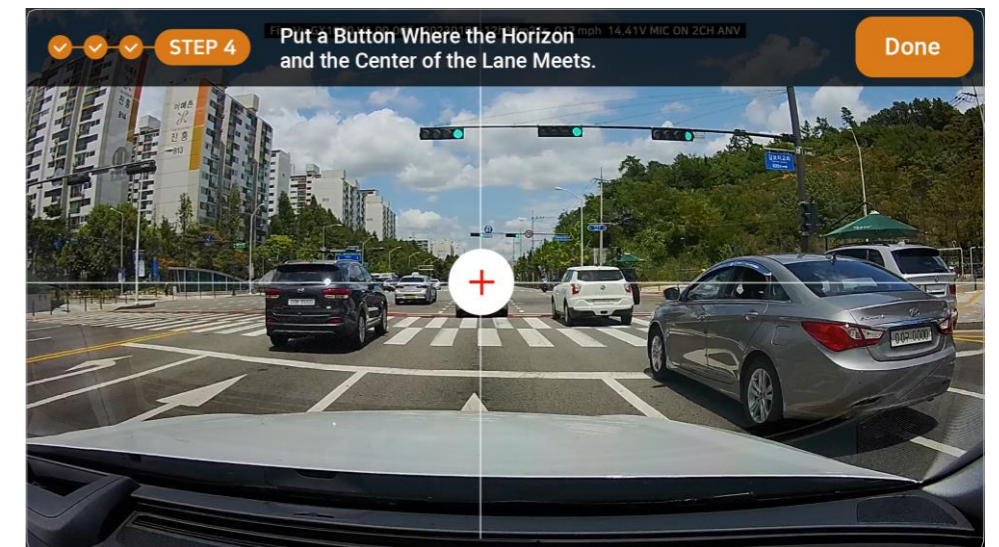

Step 4. Align the ⊕ with the center of the horizon and the lane.



- When setting the mounting angle, set it in a safe place that avoids interference from nearby vehicles.
- It is recommended to set up for ADAS accuracy.

Watching Video

1. Run the 'FineVu Wi-Fi' APP to connect with the Wi-Fi of the Dashcam. (See 'How to Use FineVu Wi-Fi APP > Installation & Connection')
2. Tap the 'Dashcam File' button on the main screen.
3. A list of recorded videos is displayed, and you can see the full view or the desired type of video, and the list of videos by date.
4. For video playback, you can check the videos with the dedicated player in the APP.

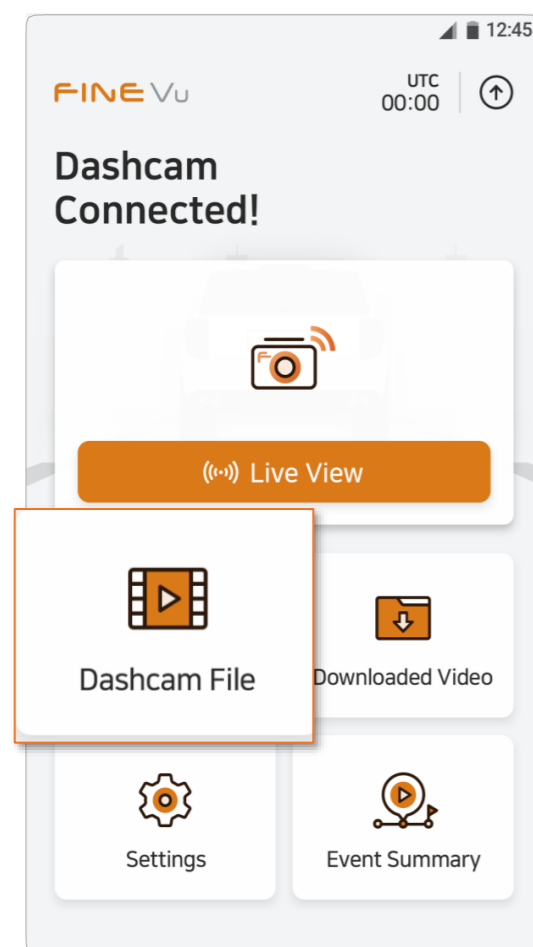

Main Screen (connected)

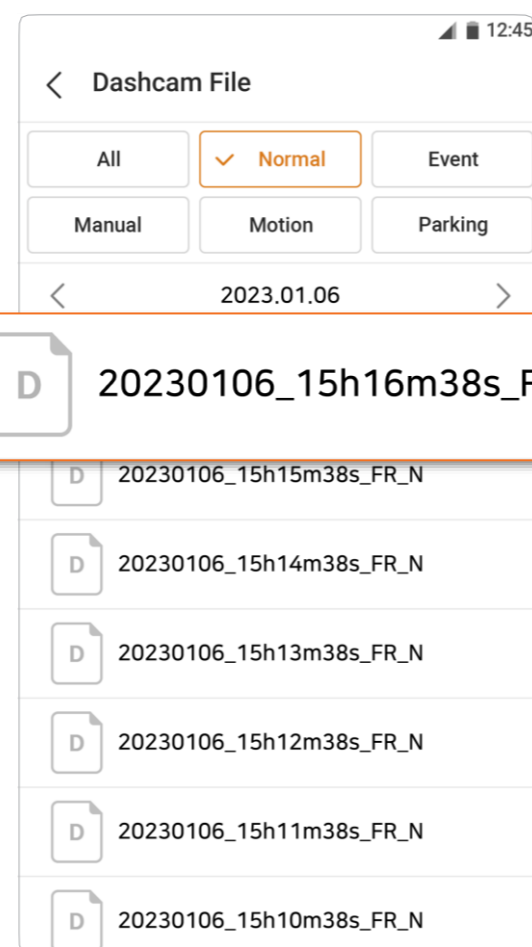

List of Recorded Videos

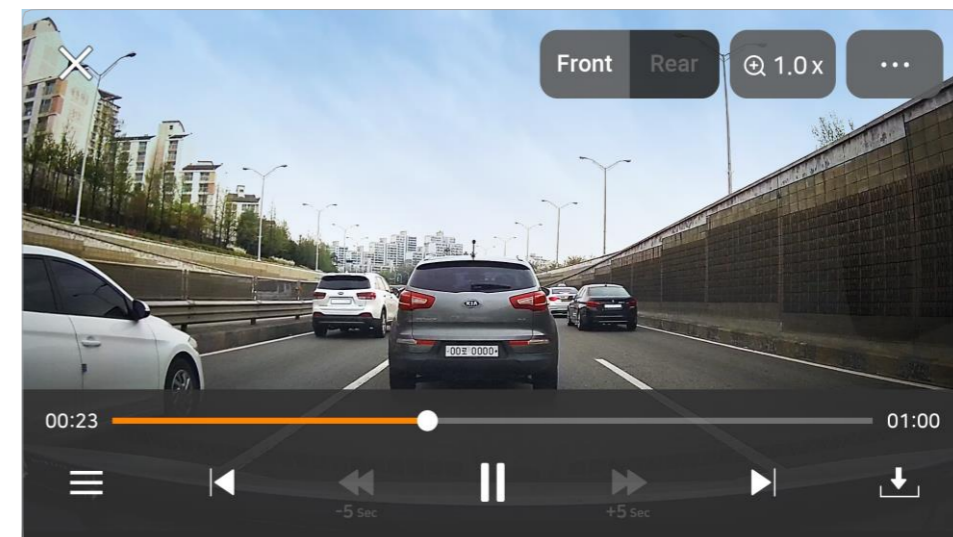

Video Playback



- The video player supports smartphone landscape mode only.
- No list will appear if there is no recorded video.

Video Player Description

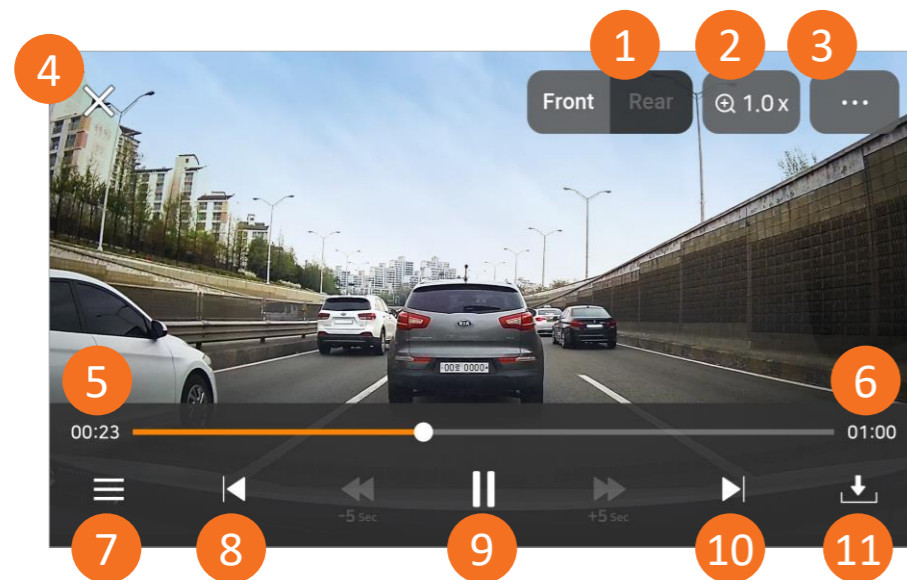

No.	Name	Functional Description
①	Front/Rear Switching	You can choose either front image or rear image.
②	Zoom	Zoom the video being played on the screen in 1.5x, 2x, and 3x.
③	Play Options	You can switch to the rear image and check file information. (Shows the file name, recording type, video length and resolution of the file currently being played.)
④	Close	Close the video player and return to the previous list.
⑤	Play Time	Shows the playing time from 00:00 seconds.
⑥	Total Time	Shows the total time of the video.
⑦	Playlist	Shows a playable list.
⑧	Previous Video	Moves from the video currently playing to the previous video in the list.
⑨	Pause	Stops the currently playing video.
⑩	Next Video	Moves from the video currently playing to the next video in the list.
⑪	Download	Downloads the currently playing video. The downloaded video is saved on your smartphone.

AI Impact Guide

1. When connected to the Dashcam, a pop-up is provided only if there is AI impact detection recorded during the previous parking mode.
2. You can check the recorded impact video by tapping the 'See Events' button.

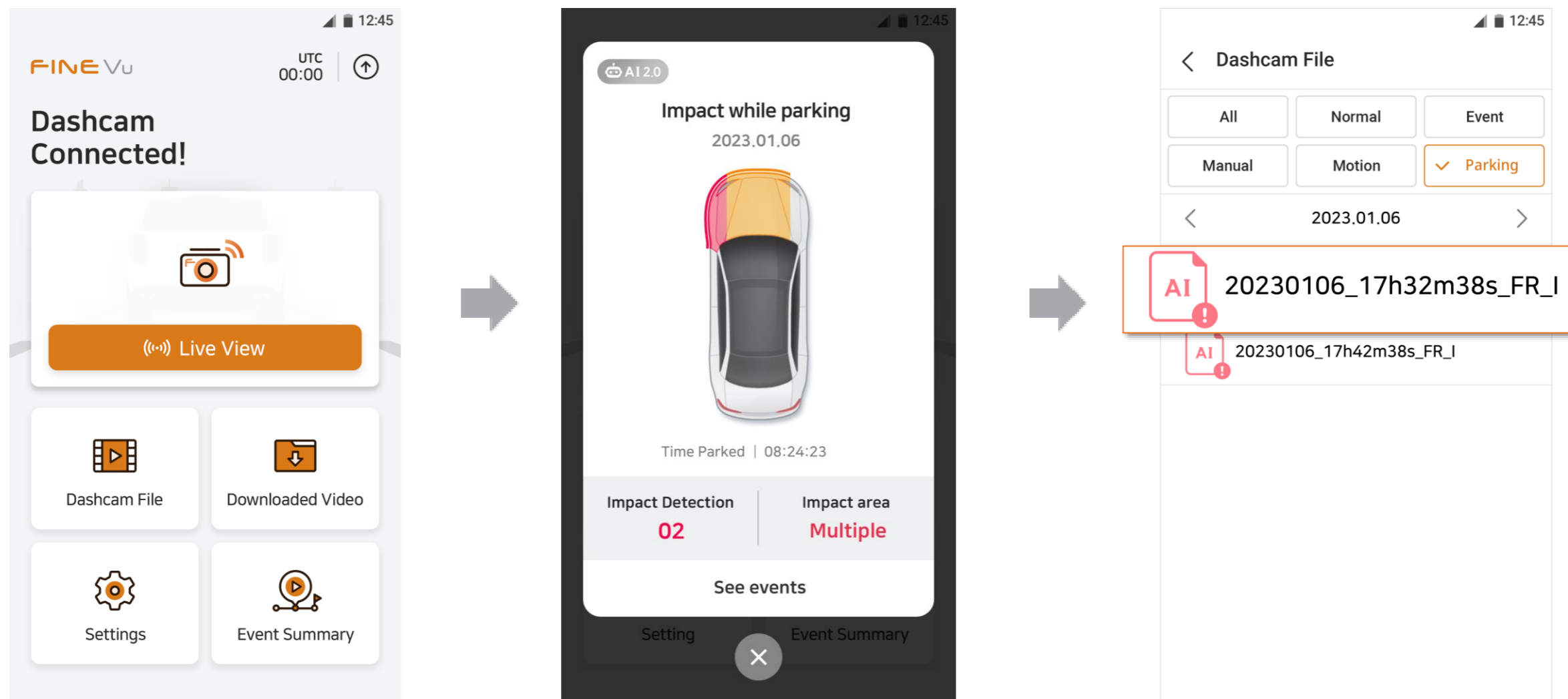

Downloaded Video

1. Tap the 'Downloaded Video' button on the main screen.
2. It provides a list of archived videos, which you can play or share.

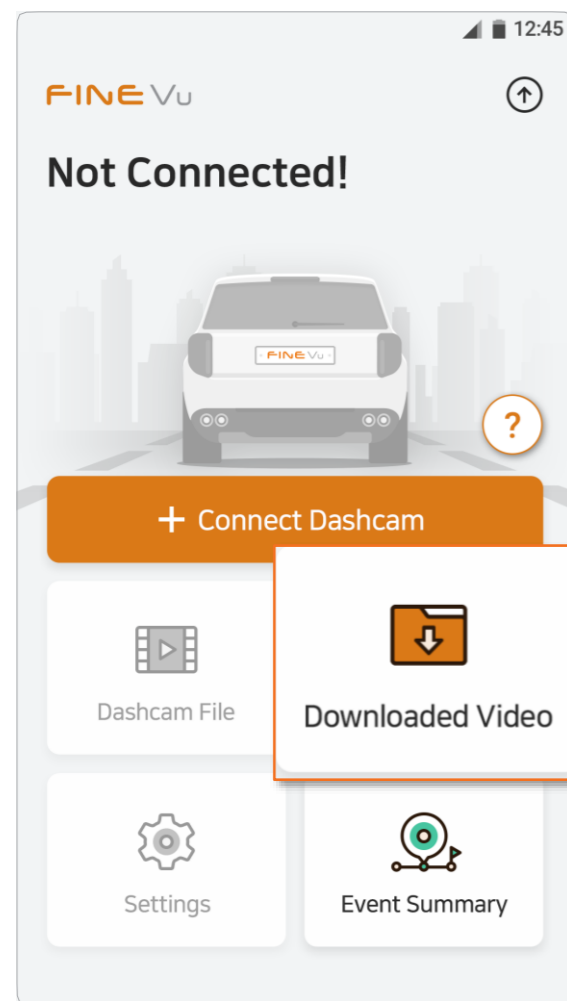

Main Screen (Not Connected)

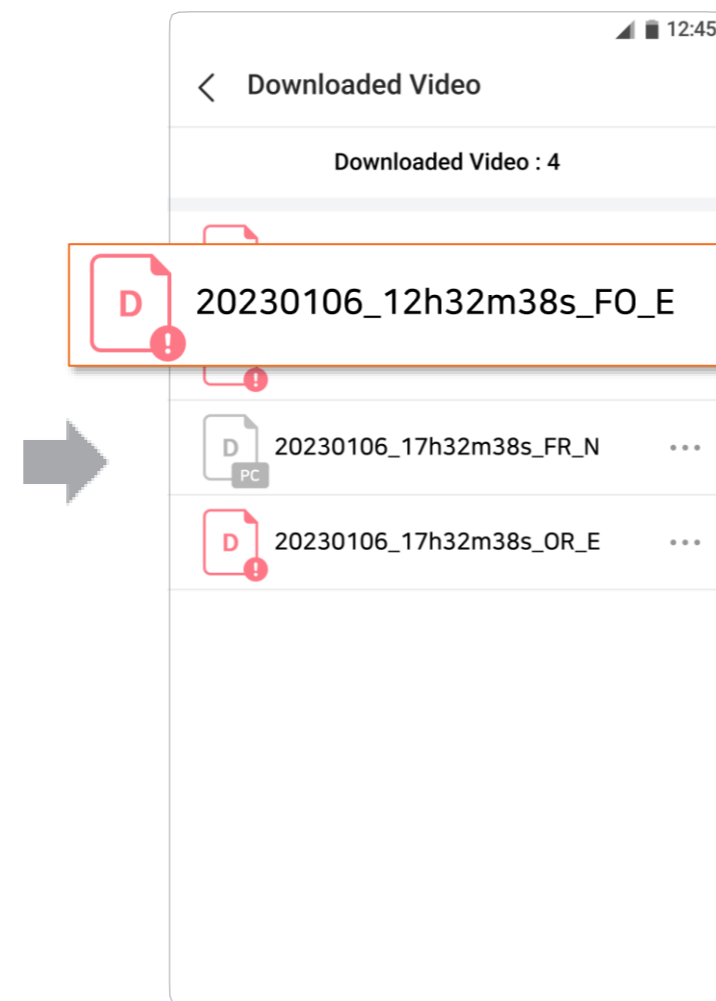

List of Downloaded Video

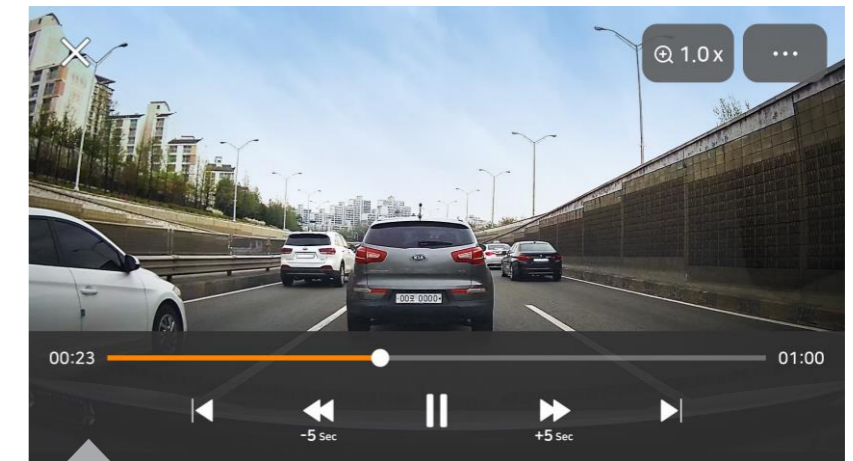

Downloaded Video Play

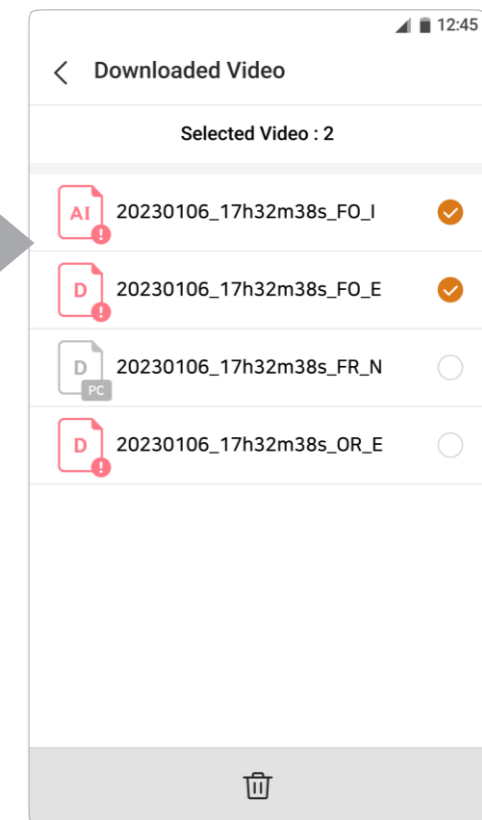

Multi-selection of Downloaded Videos



- This function is available regardless of whether or not you are connected with the Dashcam.
- The original PC video file cannot be played.

Settings

1. Launch the 'FineVu Wi-Fi' APP to connect with the Wi-Fi of the Dashcam. (See 'How to Use FineVu Wi-Fi APP > Installation & Connection')
2. Tap the 'Settings' button on the main screen.
3. You can select the menu you want and adjust the settings.

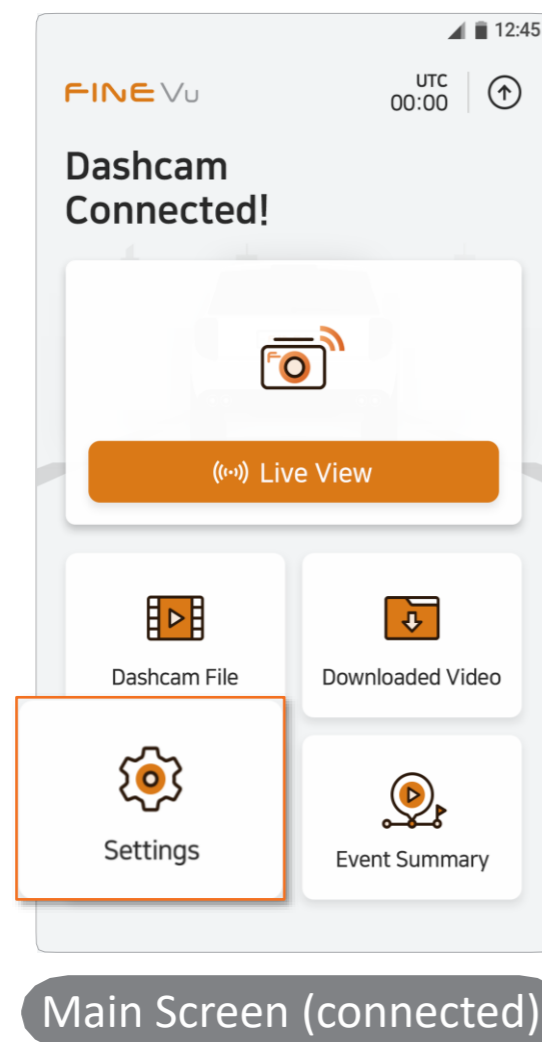

Main Screen (connected)

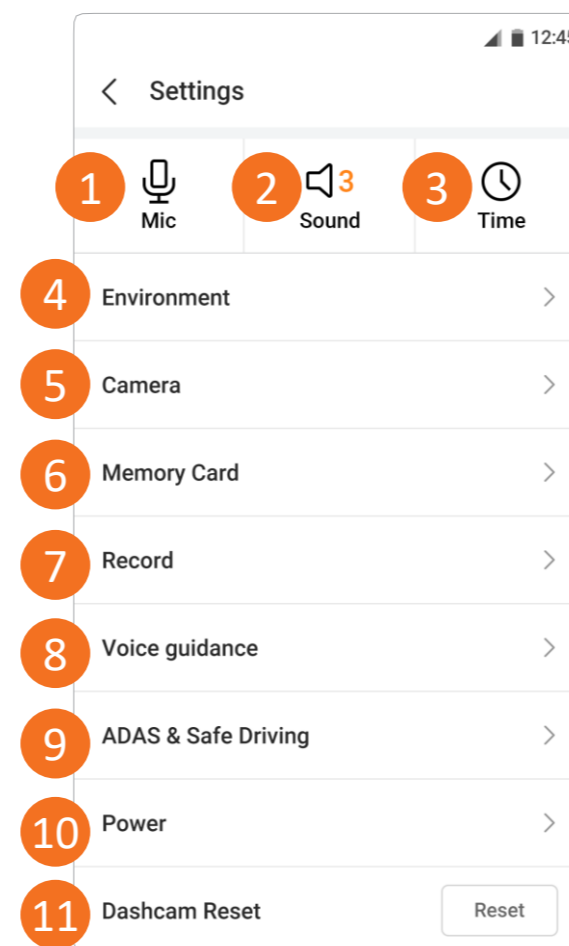



Setting Screen

No.	Functional Description
①	Mic ON/OFF
②	Volume setting (Total 5 levels - 0~4)
③	Time setting
④	Environment Setting
⑤	Camera Setting
⑥	Memory Card Setting
⑦	Recording Setting
⑧	Voice guidance
⑨	ADAS& Safe Driving Assistant Setting
⑩	Power Setting
⑪	Reset Dashcam Setting



- When the Dashcam is not connected, these functions are not available.
- When you change the Dashcam setting, the memory card may be initialized, and a pop-up appears over the APP during initialization. Please pay attention to that pop-up.

By tapping the [Settings ▶ ], you can switch the voice recording function ON/OFF, like **1** during video recording.

By tapping the [Settings ▶ ], you can adjust the sound volume of the Dashcam guide sound and guide message in 5 levels from 0 to 4.

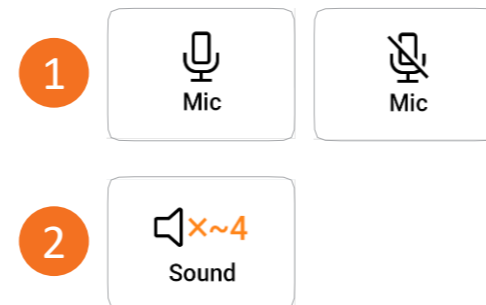
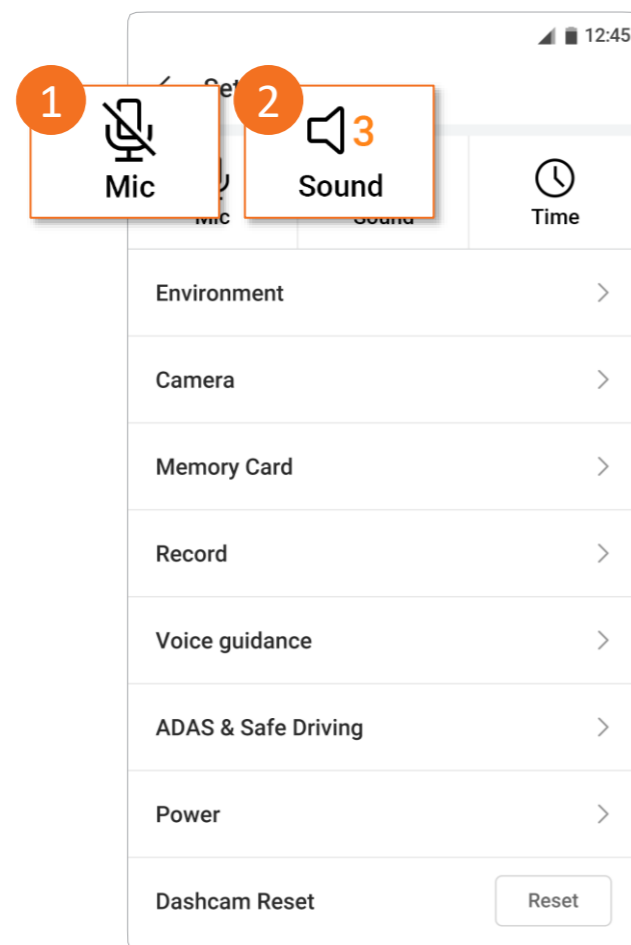

By tapping the [Settings ▶ ], you can switch the UTC time zone setting and summer time setting ON/OFF.
 (You can set UTC from -12 to +14.)

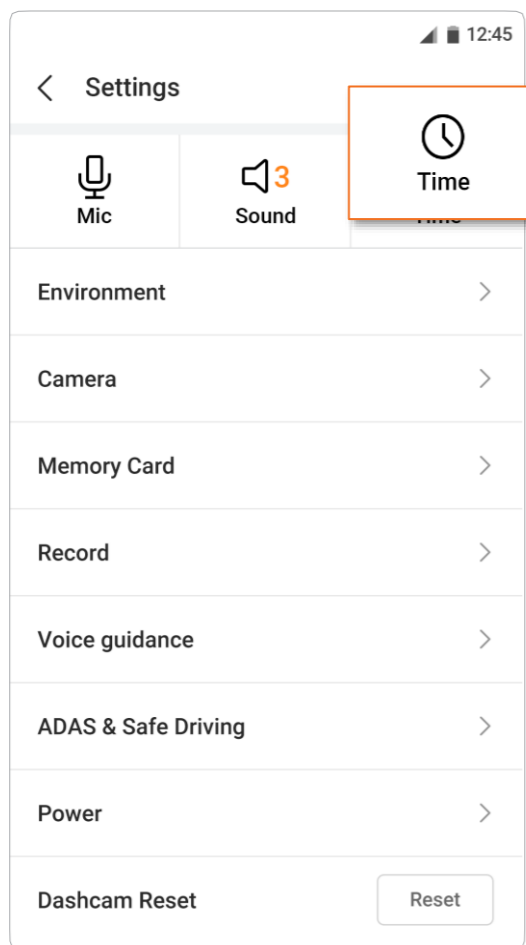

Setting Screen

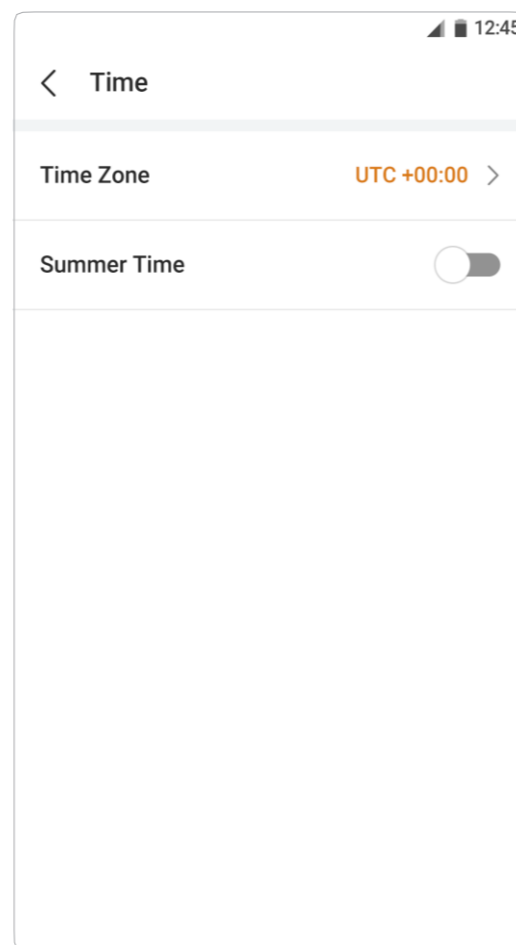

Setting Screen > Time

· UTC Guide

Region	UTC time zone
LA Vancouver	-8
Denver	-7
Chicago Mexico City	-6
New York Washington, D.C.	-5
Sao Paulo	-3
London	0
Berlin Rome	+1
Moscow	+3
Beijing Taipei	+8
Seoul Tokyo	+9
Sydney	+10



- The UTC Guide is for reference, so set the correct UTC time zone for your area of residence or use.
- If you select the UTC Change button on the main screen, the screen moves to the Time Settings screen.

By tapping [Settings ► Environment], you can set the Wi-Fi password, speed unit, OSD speed display, security LED ON/OFF, and status LED brightness control.

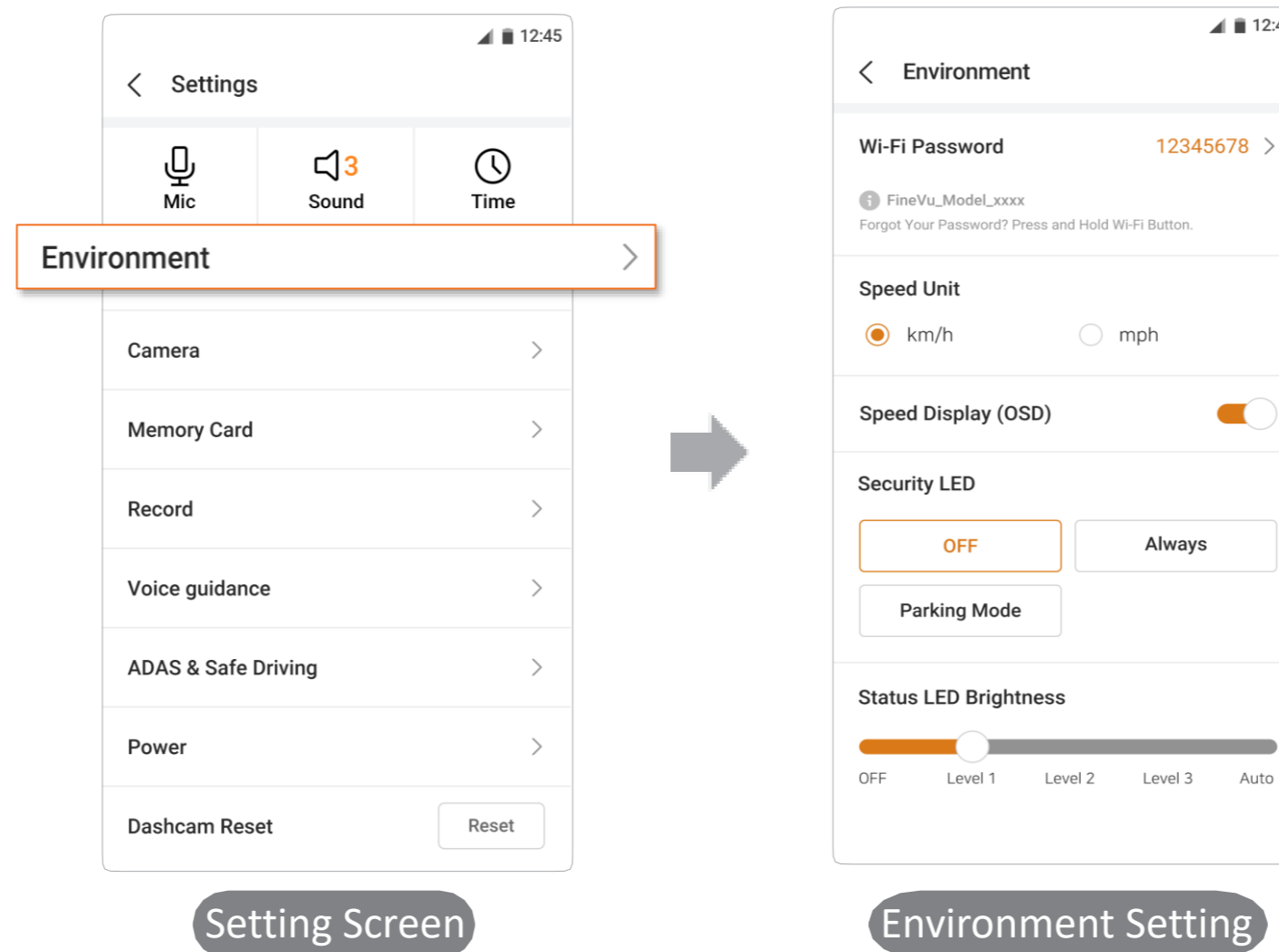

· If you forget your password, you can reset it by pressing and holding the **Wi-Fi** button on the main body of the Dashcam for longer than 3 seconds. (See the 'How to Use > Button Description')

By tapping [Settings ► Camera], you can turn the HDR function ON/OFF and adjust the brightness of the rear image.

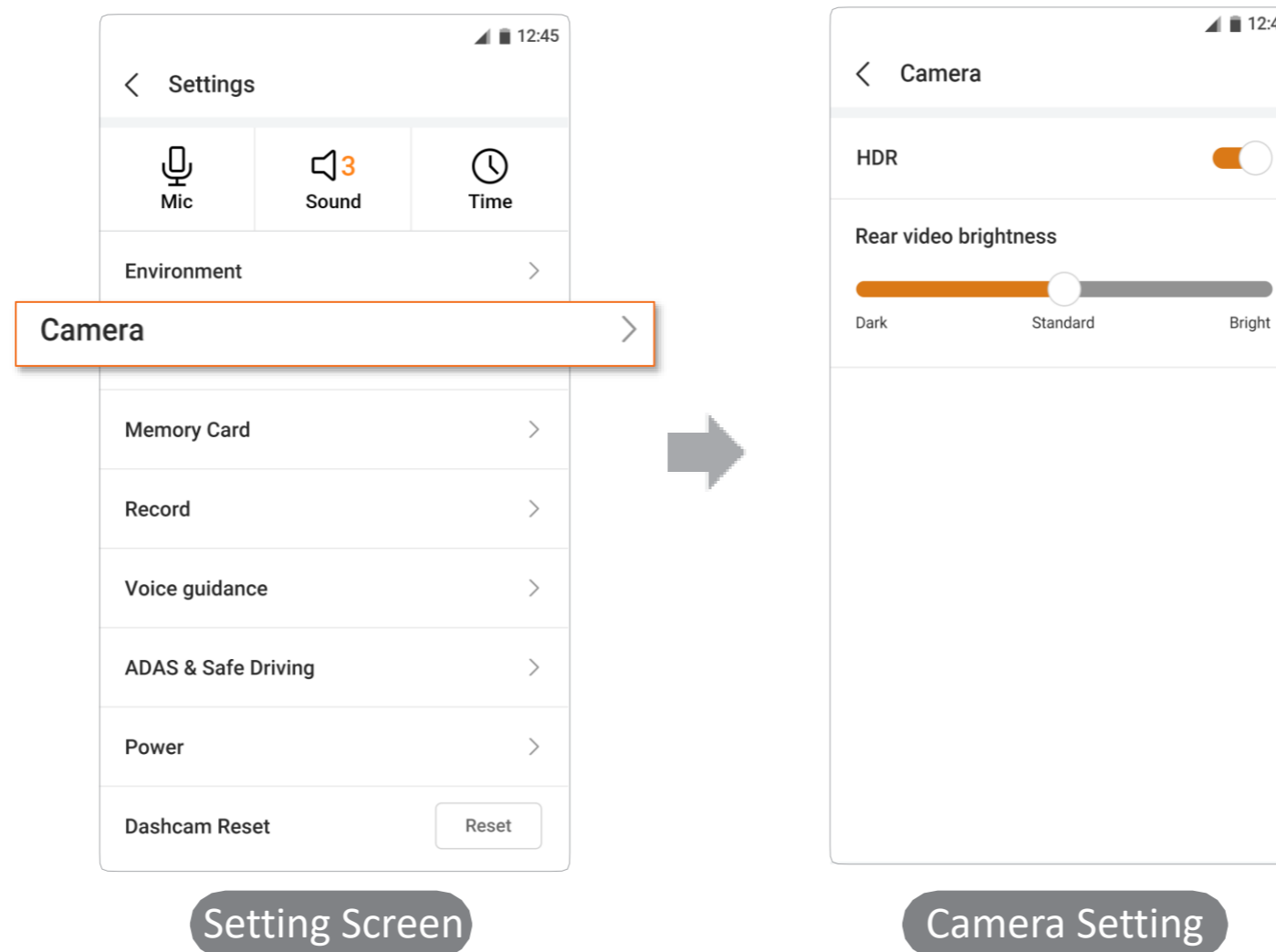

By tapping [Settings ► Memory Card], you can select one of 4 types of memory partitions and set overwriting restrictions.

(4 types of memory partitions – Driving Priority, Event Priority, Parking Priority, Driving Only)

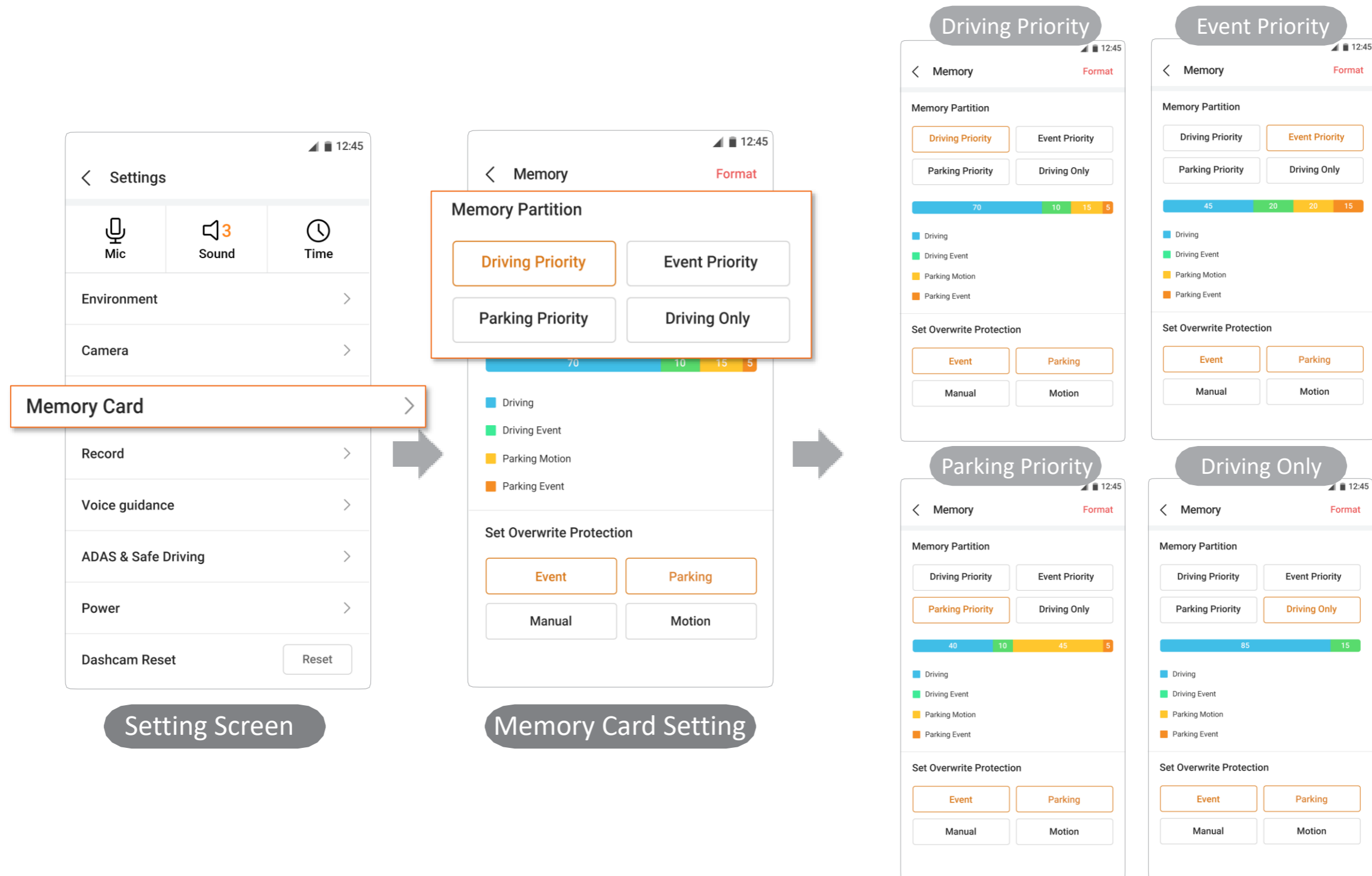

- When the overwriting restriction is set, the videos are saved up to the allocated capacity. Once the allocated range is full, videos are no longer saved.
- This option will not be reset even after the memory card settings are formatted.

By tapping [Settings ► Record], you can set the recording type for driving and parking recording, impact sensitivity, motion sensitivity, etc.

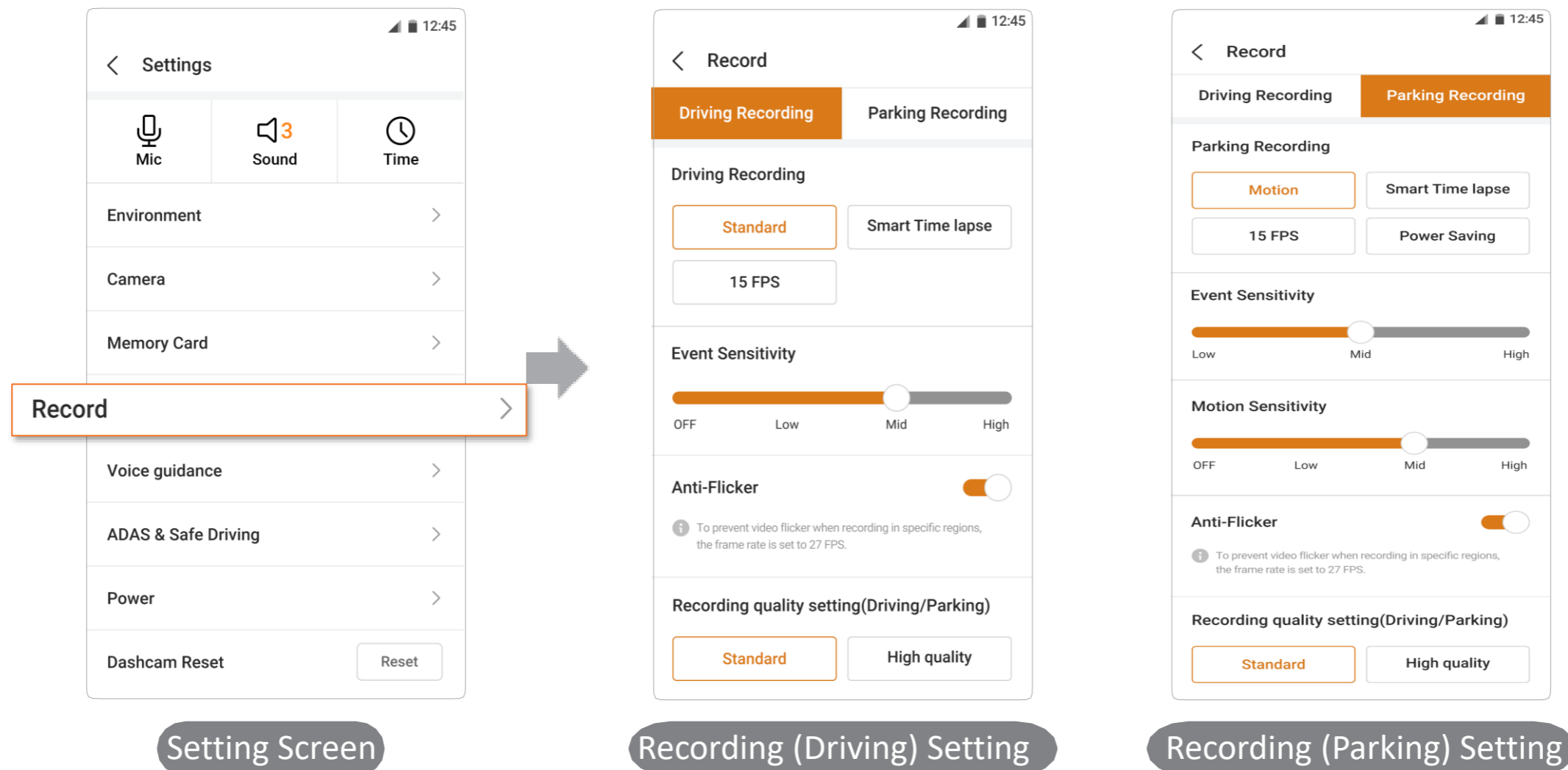

- Recording type (Standard, Smart Time Lapse, 15fps)
- Event sensitivity
- Anti-flicker
- Recording quality setting (driving, parking)

- Recording type (Motion, Smart Time Lapse, 15fps, Power Saving)
- Event sensitivity
- Motion sensitivity
- Anti-flicker
- Recording quality setting (driving, parking)

Through the [Settings ► Voice guidance], you can configure Wi-Fi Status, Camera and Recording voice guidance.

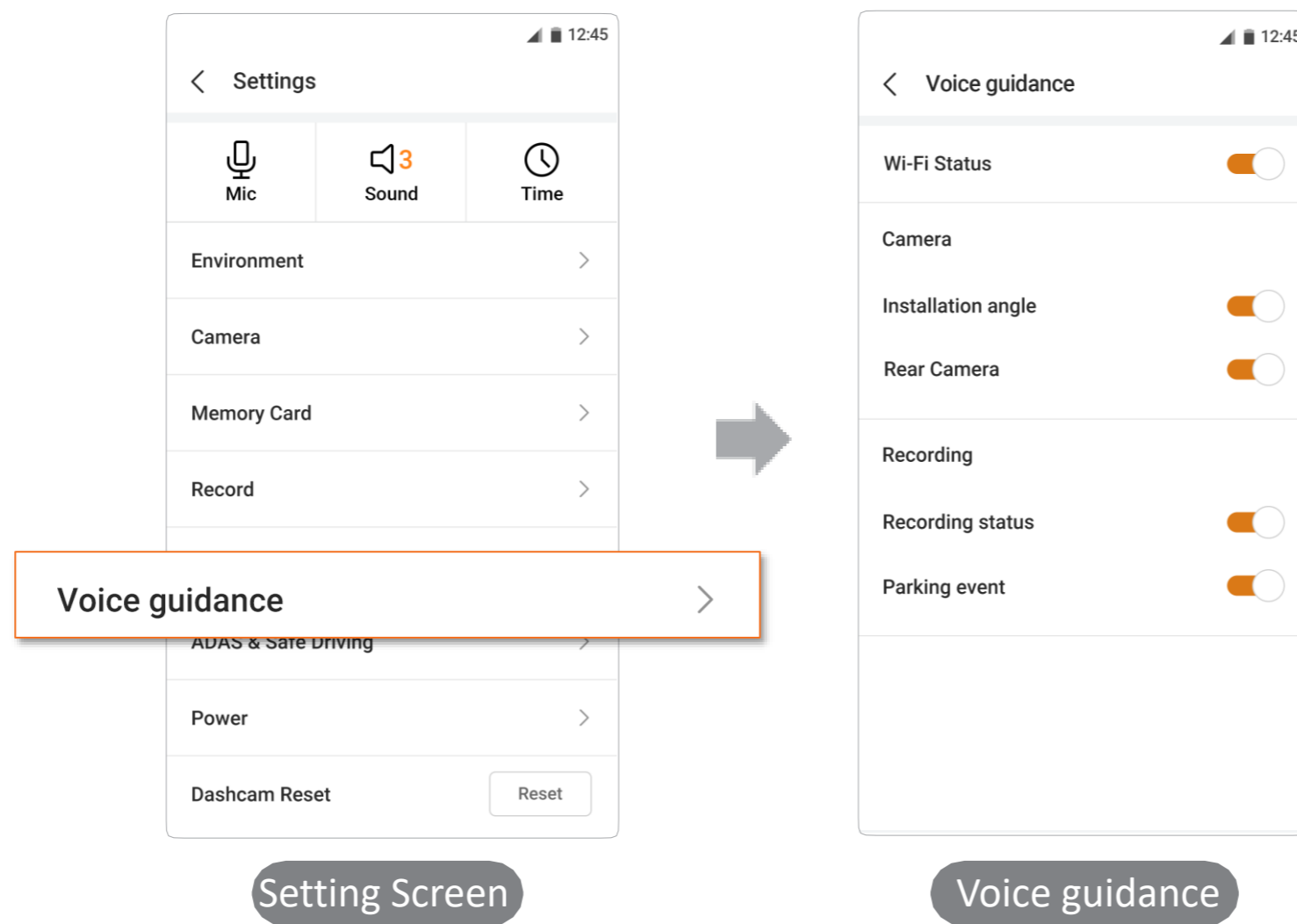

Through the [Settings ► ADAS & Safe Driving], you can configure FVMA, On-Time notification, Speed Camera Notification, Mobile Camera Alert, and Driving Rest Notification.

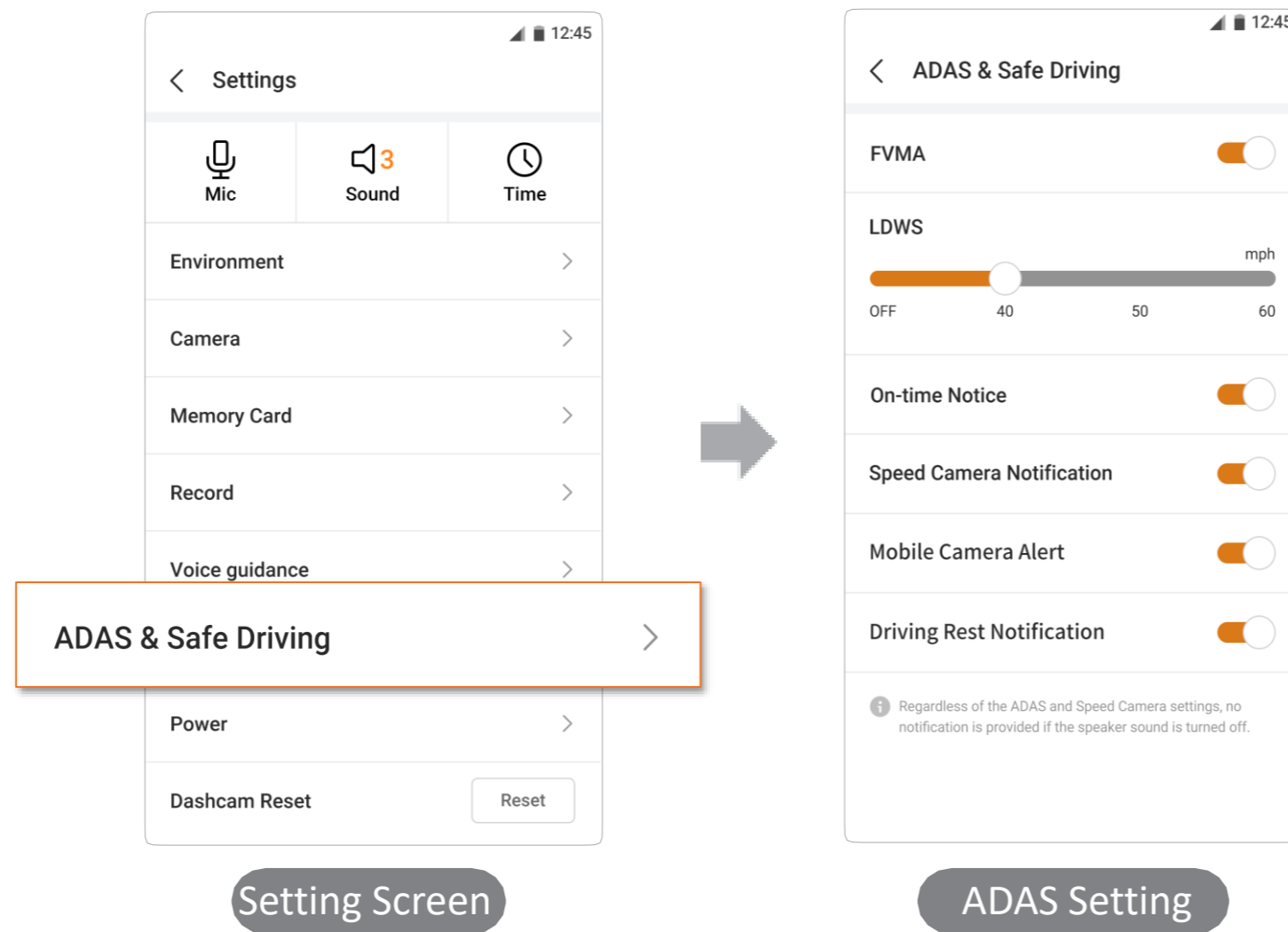

Setting Screen

ADAS Setting

Through [Settings ► Power], you can set low voltage and cut-off time.

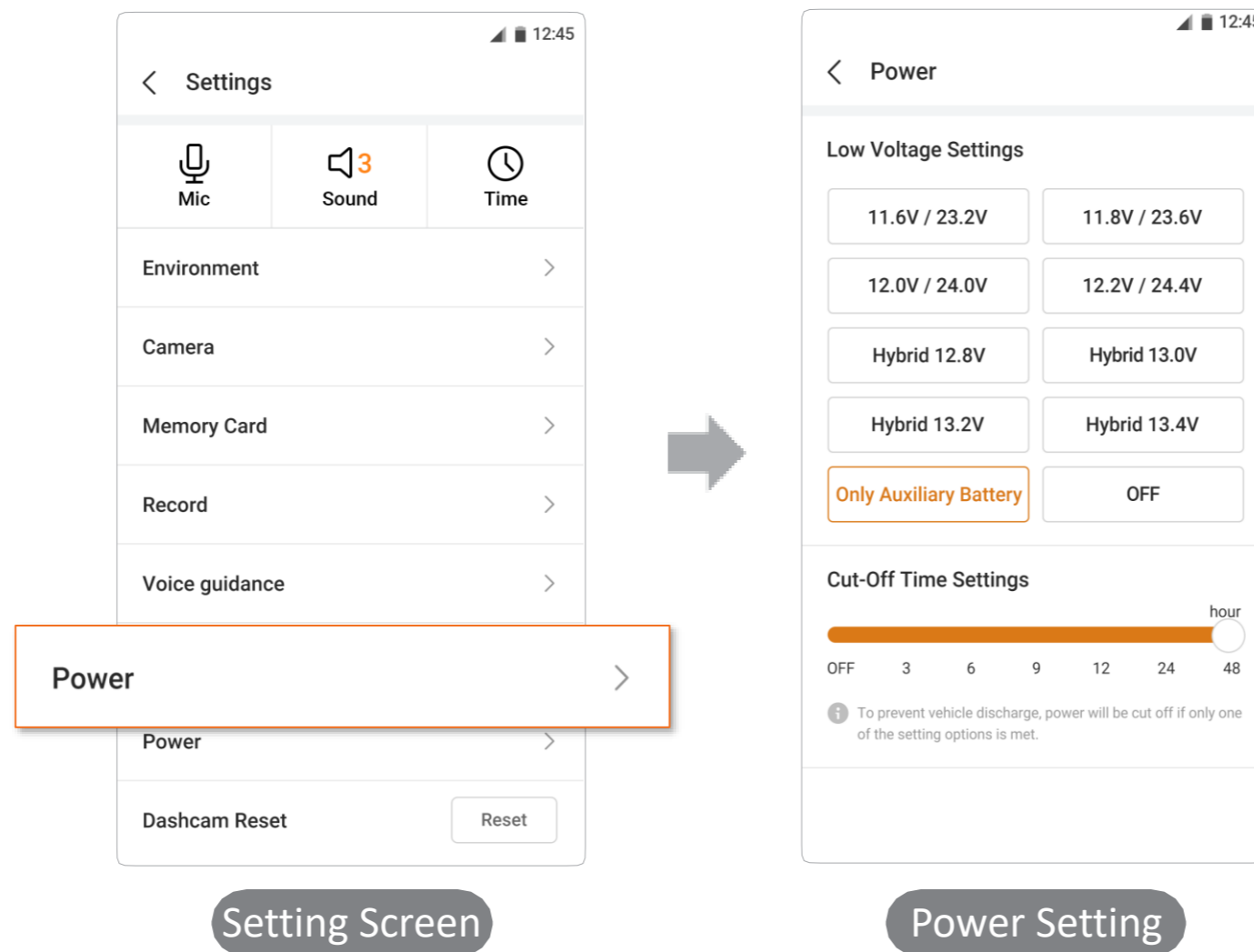

Setting Screen

Power Setting

By tapping [Settings], you can reset the Dashcam setting and the memory card.

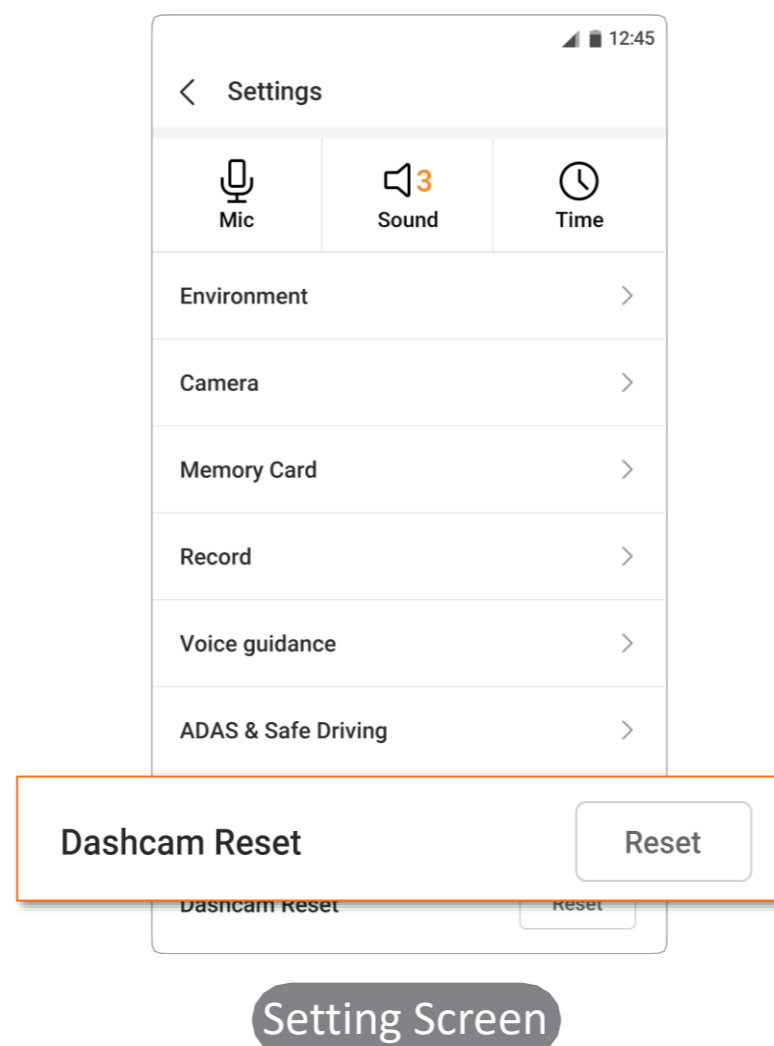

- If you change the memory allocation to a value other than the default value, the memory card will be formatted. Please ensure that you have saved any important videos to a separate device before proceeding.

Event Summary (connected)

With the Event Summary function, you can check the details of the events that occurred and get video or map information of the events.

1. Launch the 'FineVu Wi-Fi' APP to connect with the Wi-Fi of the Dashcam.
(See the 'How to Use FineVu Wi-Fi APP > Installation & Connection')
2. Tap the 'Event Summary' button on the main screen.
3.  When you tap that button, a playlist of relevant events (driving or parking) is provided.

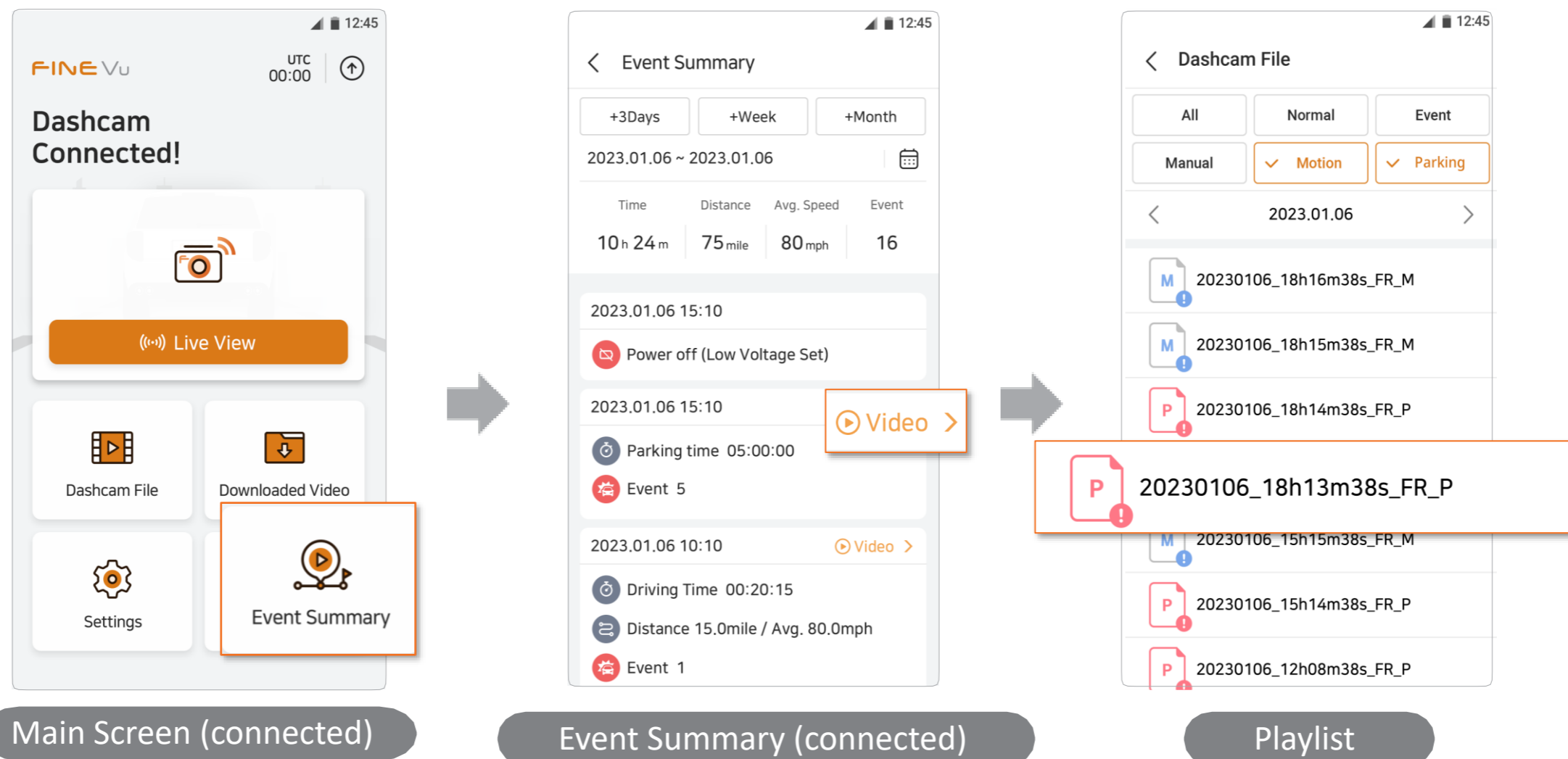

- No list will be shown if there is no data stored.
- When the Dashcam is not connected, the map screen rather than the play screen will be provided.

Event Summary (connected) Explanation

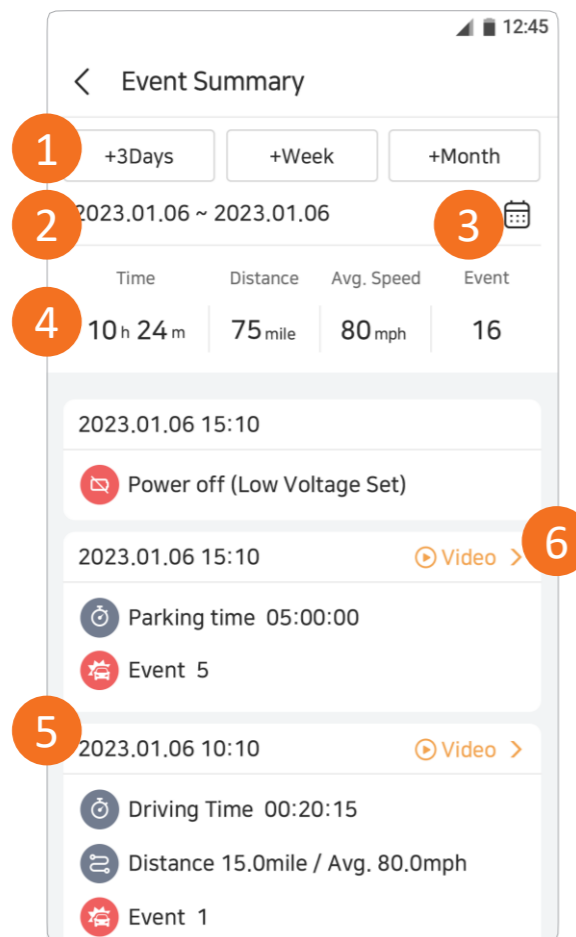

No.	Functional Description
①	Choose 3 days, a week or a month
②	Selected period
③	User-defined period selection
④	Driving time, driving distance, average driving speed, and number of events over the selected period
⑤	Summary of information including power on/off and number of events over the selected period
⑥	Provides a list of videos related to that event (driving or parking)

Event Summary (disconnected)

Through the Event Summary function, you can check the details of the events that occurred also get video or map information of the events.

1. Tap the 'Event Summary' button on the main screen.
2. When you tap that button, information including a map screen and departure/arrival locations is provided for the relevant contents.

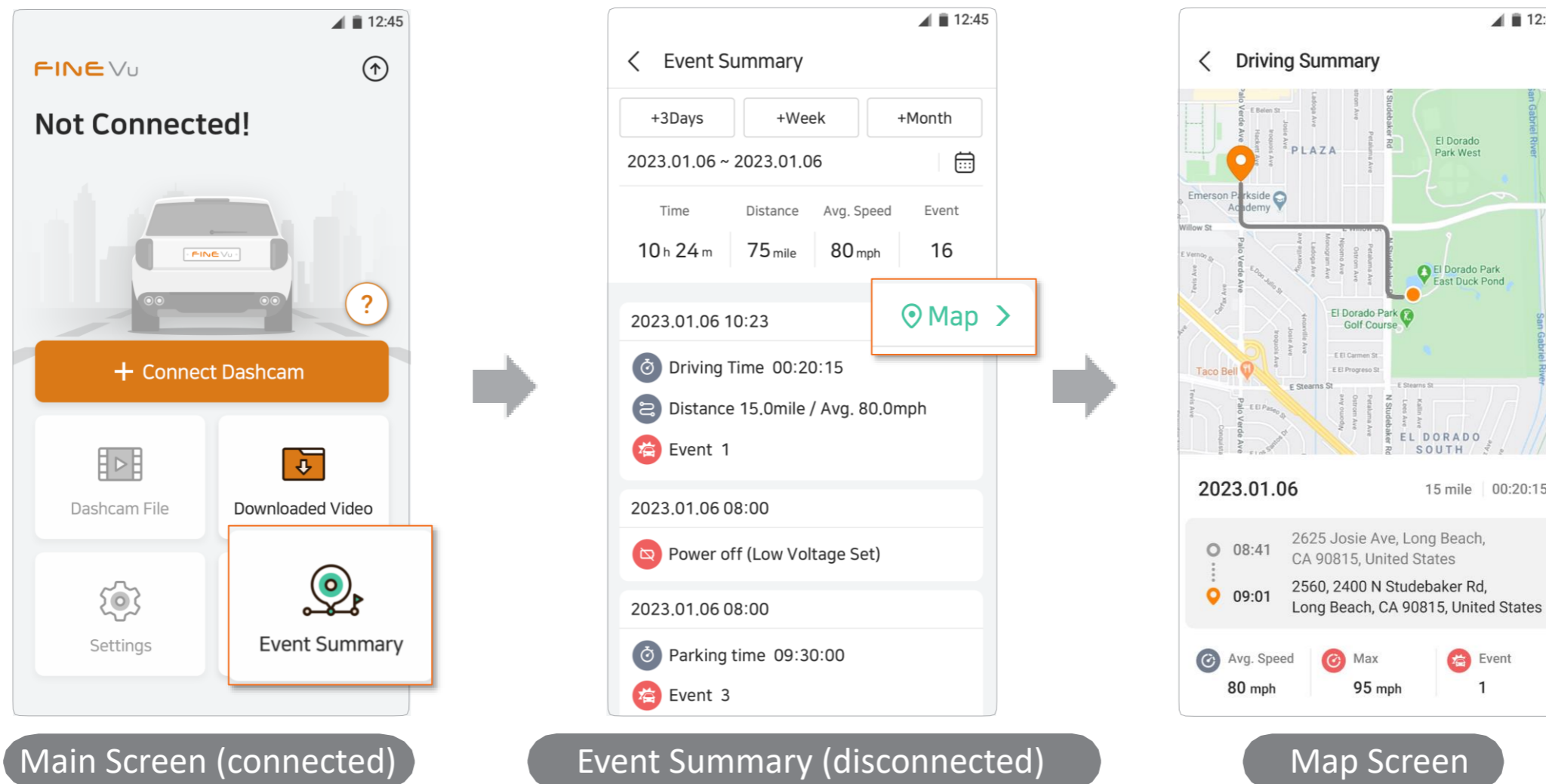

- No list is provided when there is no data.
- When the Dashcam is connected, the video screen, rather than the map screen, is provided.

Event Summary (disconnected) Explanation

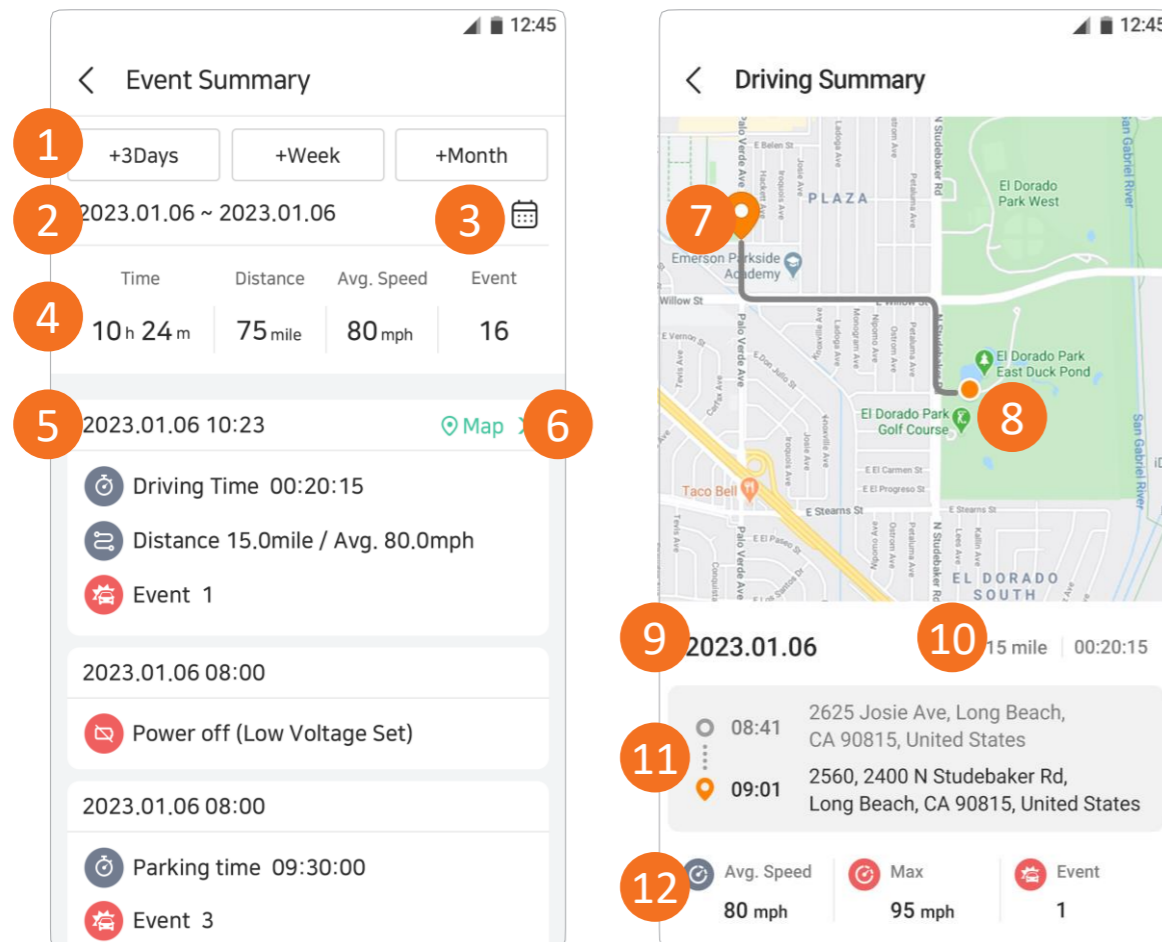

No.	Functional Description
①	Choose 3 days, a week or a month
②	Selected period
③	User-defined period selection
④	Driving time, driving distance, average driving speed, and number of events over the selected period
⑤	Summary of information including power on/off and number of events over the selected period
⑥	Provide maps and details for the relevant contents
⑦	Departure
⑧	Arrival
⑨	Date
⑩	Driving distance, driving time
⑪	Departure, arrival time and address
⑫	Average driving speed, maximum driving speed, number of events

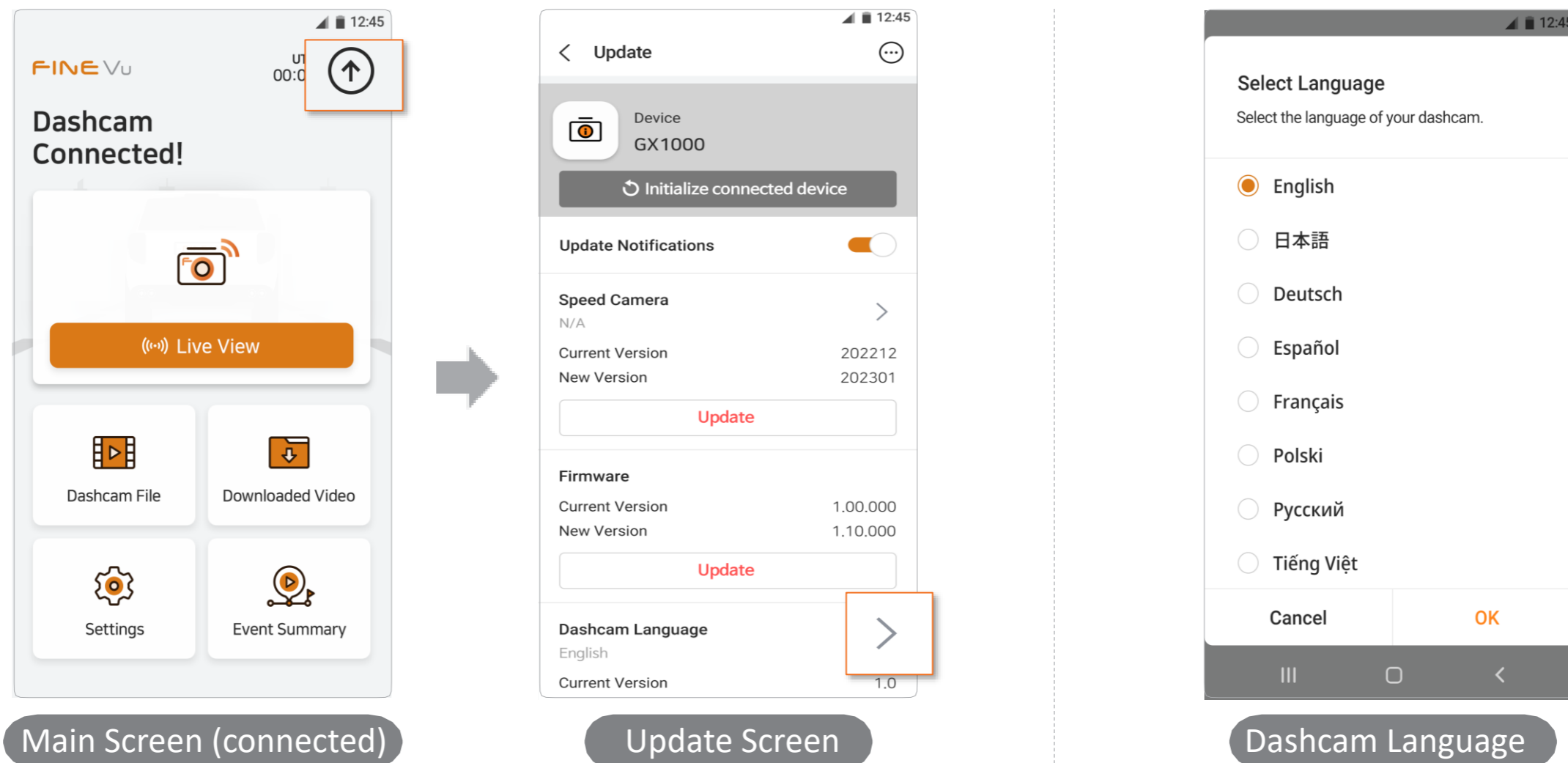

Change the dashcam language

1. After connecting the Dashcam, tap the  icon at the top right on the main screen.
2. You can change the guidance language of the Dashcam through the update screen.



- When the dashcam language is changed, the Dashcam reboots.
- In addition to the dashcam language, the APP language may be changed depending on your smartphone settings.

Updating Firmware from APP

1. After connecting the Dashcam, tap the  icon at the top right on the main screen.
2. You can check the name of the connected Dashcam and relevant Dashcam App, and version & open license  information of Speed Camera, firmware, and dashcam language
3. After checking the version of the App, Speed Camera, firmware, and dashcam language, if it does not match the latest version, tap the **Update** button to proceed with the update.

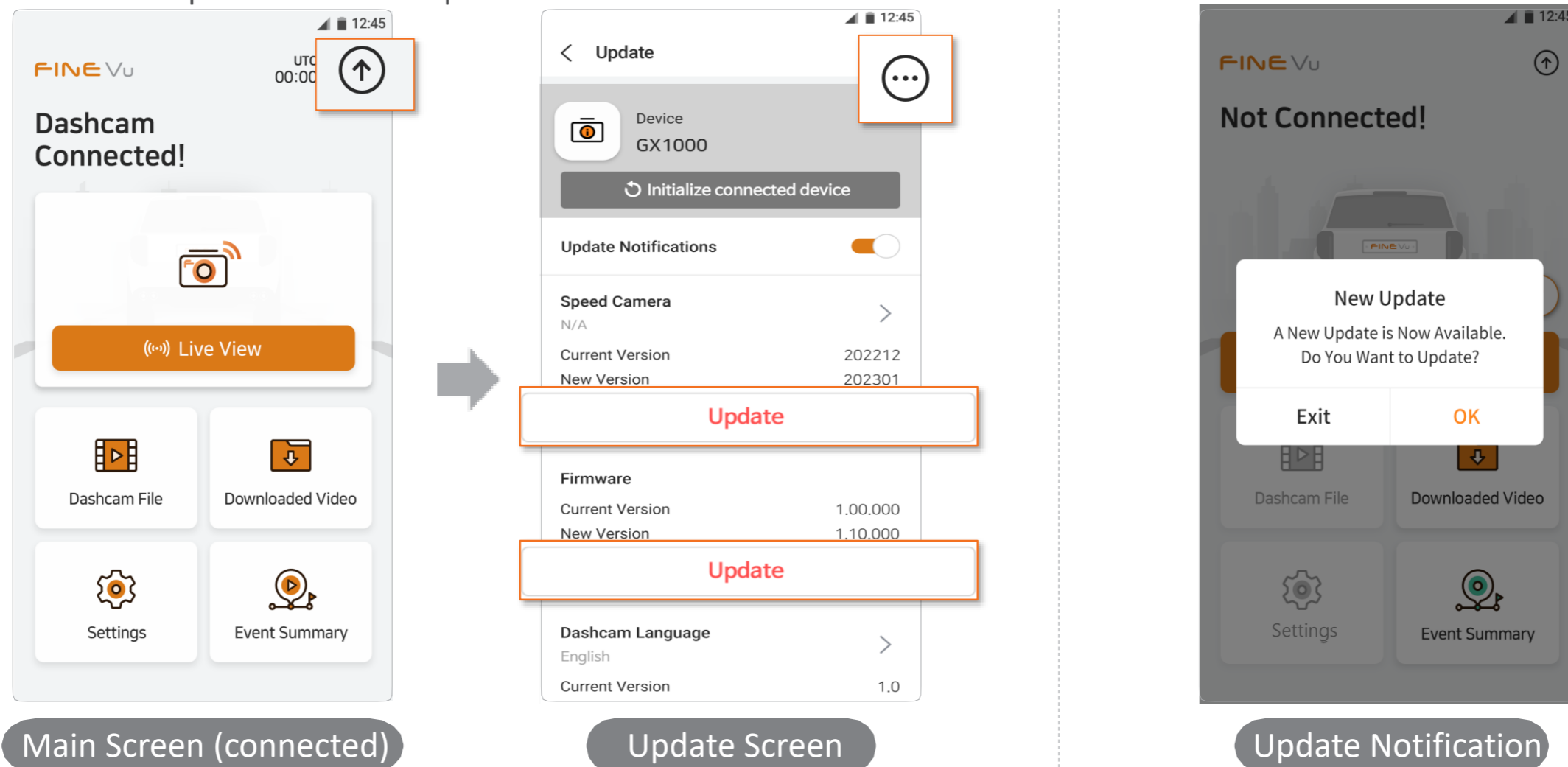

- When there are new updates, you will be notified through a pop-up when connected to the Dashcam, and you can proceed with the update by tapping the 'OK'.
- The update notification pop-up may not appear depending on factors in the environment, such as the connection status.

How to use FineVu player

How to Install & Use

FineVu player is an app that can play the video files recorded by the FineVu Dashcam. Please download it via the website and install it.

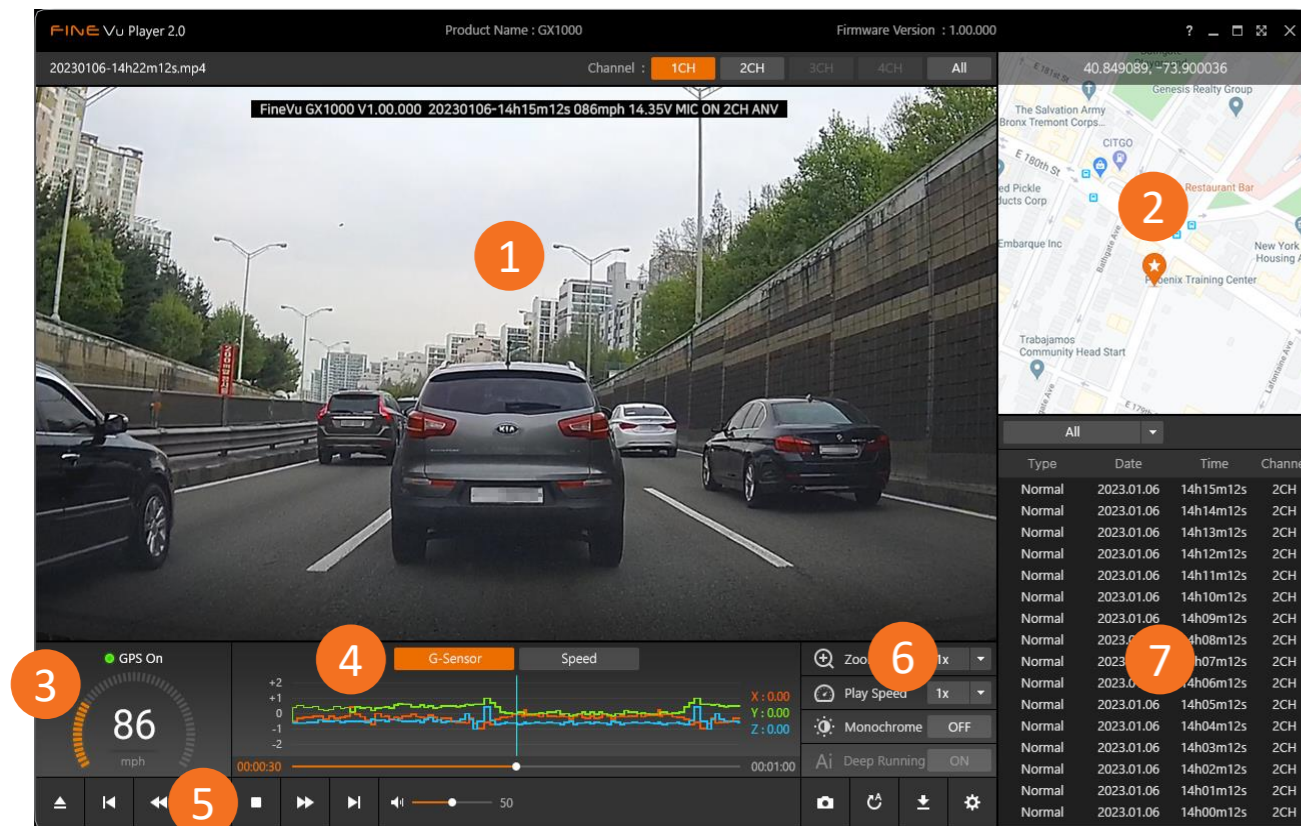

No.	Functional Description
①	The main window in which the recorded video is played.
②	If the recorded video contains GPS information, the location is displayed on the map.
③	If the recorded video contains GPS information, the driving speed is displayed.
④	The G-Sensor value or driving speed is graphed.
⑤	This menu allows you to play and back up the videos, and set up the players.
⑥	This menu helps users to analyze recorded videos.
⑦	This displays the list of recorded videos.

Recommended specifications for PC

	Recommended Specifications
OS	Windows 10, 64bit OS
HDD	150MB
CPU	Intel Dual Core 3.4GHz
VGA	1GB
RAM	4GB
DirectX	DirectX 12
Monitor	1920 x 1080



- FineVu player is available for both Mac and Windows computers.
- It is not recommended to use a player other than FineVu player.

View Recorded Video & Update Firmware on PC

• View Recorded Video on PC

1. Take the Micro SD card out of the product, insert it into the adapter, and connect it to the PC using the reader.
2. When the card connects to the PC, a new volume will appear on the PC desktop.
3. You can play or view saved video files by opening their respective folders.
4. The recorded video can be played with a commercial player or FineVu player, a dedicated PC viewer.

(Please note that only the dedicated FineVu player will show you the GPS information and G-Sensor information embedded in the recorded video.)

• Update Firmware on PC

1. Download the latest firmware from the website. (<http://www.FineVu.com>)
2. Take the Micro SD card out of the product, insert it into the reader, and connect it to the PC.
3. When the card connects to the PC, a new volume will appear on the PC desktop. (It is recommended to format the Micro SD card if it was used in other devices before updating.)
4. Decompress the downloaded firmware and copy it to the root folder in the Micro SD card.
5. After inserting the copied Micro SD card into the product, turn on the power of the vehicle (ACC On) or start the engine to turn on the product.
6. The firmware update will be performed automatically.
7. Once the firmware update is complete, the product reboots automatically.



· When inserting or removing a Micro SD card, please refer to 'How to Install' on the previous page.

Product Specifications and Size

Item	Specifications	Remarks
Model name	FineVu GX1000	
Size/Weight	Front: 96.5 x 70.0 x 26.5mm / 114g Rear: 29.2 x 36.5 x 29.2mm / 23g	Weight is includes the cradle (without cable)
Supportive Capacity	Micro SD card 32GB / 64GB / 128GB	Class 10 or above, SDXC support
recording type	Driving recording	Recording every minute
	Impact detection recording	For 20 seconds (previous 10 seconds/next 10 seconds)
	Quick recording	For 20 seconds (previous 10 seconds/next 10 seconds)
	Parking recording (Recording when impact or motion is detected)	For 20 seconds (previous 10 seconds/next 10 seconds)
	Driving time lapse recording	Standard 30fps recording in the event of impact
	Parking time lapse recording	Standard 30fps recording in the event of impact
Lens	Front/rear Quad HD class wide-angle lens	
Image Sensor	Front: 5.14M pixels CMOS Image Sensor (1/2.8")	
Angle of View	Front: 139 degrees diagonal, 105 degrees vertical, 77 degrees horizontal Rear: 141 degrees diagonal, 106 degrees vertical, 77 degrees horizontal	
Video	Front: 2560x1440@30fps	
Voice	Built-in microphone	
Speaker	Built-in speaker	

Item	Specifications	Remarks
Acceleration Sensor	3-axis acceleration sensor	+2g / -2g
Input Power	DC 12V-24V	
Battery	Super capacitor	When external power is turned off, power supply for safe video storage
Power Consumption	Approx. 5.0W (in parking motion mode) Approx. 0.06W (in low-power mode)	2ch default, GPS off
Operation temperature	Operation temperature -20°C ~ 70°C / storage temperature -30°C ~ 80°C	
Interface	Power port (3.5Φ)_3 lines, rear camera port (2.5Φ), Wi-Fi port (USB A Type), Micro SD card slot	
Supportive Functions	FineVu Wi-Fi App, ADAS(FVMA), Smart Time Lapse, Auto Night Vision, HDR, Safe Driving Assistant 2.0, mounting angle guide, battery discharge prevention, low-power, high temperature blocking, on-time guidance, drowsy driving prevention guidance, and 1 channel recording support	Vehicle speed, ADAS, and Safe Driving Assistant functions are work only when the GPS is connected (receiving).
Certification Number	R-R-FDK-FineR049 Model Name: FineVu GX1000 Manufacturer: FINEDIGITAL Inc. Year of manufacture: Marked separately Certified trade name: FINEDIGITAL Inc. Name: Drive recorder Country of manufacture: South Korea	Passed the KS C 9990 (Test for Electromagnetic Compatibility of Automobiles and Internal combustion Engines)



A good way to manage
your
Micro SD card!

1 Latest firmware update

If you make sure to keep the firmware version up-to-date, you can minimize errors in the Dashcam by ensuring the system is stable.

2 Regular recording check

Recorded videos may be deleted over time, so check the recorded videos regularly and make sure to back up important files.

3 Memory card warranty

Memory cards are consumables with limited usage due to continuous video recording, and so regular inspection or replacement is required.

- The free warranty period for a memory card is 6 months, and if there is a defect in the memory card after that, you will need to purchase another card.
- You are recommended to format your memory card once every two weeks.

Latest firmware update: www.FineVu.com/en

FINE VU

<http://www.finevu.com/en>

FineVu Customer Satisfaction Center : support@finedigital.com

This manual describes the functions of the product.